



Instant Heat 3-in-1

Non-Ducted 4 Heat Lamps
Cat BH4NDWE / BH4NDMS

Instruction Manual

Non-ducted heater, exhaust fan and LED light

Specification

Supply voltage: 230-240Vac
Frequency: 50Hz
Max Power Consumption: 1240W
(May be connected to a light or power circuit if loading permits.)

Please read carefully

Read through these instructions completely before commencing installation.

CAUTION

This product is not designed to be ducted. Do not fit after-market ducting kits. If ducting is required then the ducted Instant Heat series, R622D1HP, R622D2 are more suitable for this purpose.

Regulations concerning the discharge of air have to be fulfilled. Local building codes may require venting to the outside. The volume of the roof space must be a minimum of 3 cubic metres and adequately ventilated to allow moisture to dissipate

This product is to be installed in standard roof applications only, not in restricted ceiling cavities as found in multi-storey applications (See Fig. 1)

Installation:

The infrared lamps heat by direct radiation rather than by heating the air in the room, so the Instant Heat should be located directly over the drying area.

HPM Instant Heat must not be installed where there is a possibility of water splashing on to the lamps. Locate in accordance with the requirements of the Australian/New Zealand Wiring Rules AS/NZS 3000 relating to damp situations. This means that no part may be located directly above any part of the bath or shower recess or enclosure. For unenclosed showers refer to Wiring Rules conditions.

Note: Steam will only be removed if there is sufficient flow of air through the room. Ensure adequate inlets exist through windows, vents or under the door. Air-flow path from inlets to fan should ideally pass over the steam sources.

Location:

The Instant Heat is for ceiling mounting only, with the lowest point to be at least 2.2 metres above floor level. It is not intended to be installed in wardrobes or within 300mm of sides of walls, as per Figure 2. There is a danger of combustion if placed too close to curtains or other flammable materials

Note: Instant Heat products must only be installed horizontally in ceiling

Ceiling preparation:

Instant Heat may be installed either between joists using the built-in clip fasteners or against a joist using a screw to replace a clip. Drill a hole in the flange to suit.

The clearances between Instant Heat and adjacent building members shown in Figure 3 shall be observed. Thermal insulation or similar material shall not be placed on top of the unit, and adjacent material to the side shall be kept clear to a minimum distance of 200mm (Fig 4).

Joists, beams and rafters shall not be cut or notched to install Instant Heat.

After determining the location of Instant Heat use this template to mark out and cut the aperture (Fig 5). If adequate support is not available for Instant Heat, it may be necessary to provide extra strengthening.

Fixing to ceiling:

Remove all lamps to prevent damage from clip fasteners. Spin the fan to check for freedom of rotation. Push the Instant Heat body into the opening allowing the springs to snap open. To secure, push the lower ends of the springs apart (Fig 6). Ceiling board thickness should be adjusted to enable the springs to be fitted without excessive force.

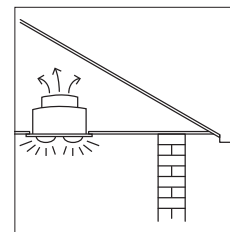

Fig 1

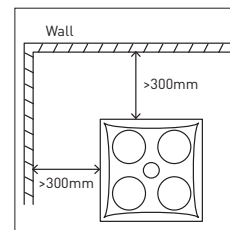

Fig 2

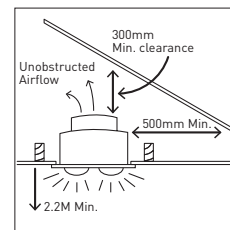

Fig 3

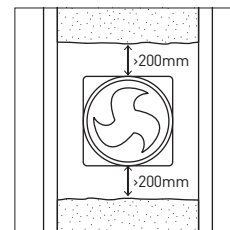

Fig 4

Final assembly:

Check that the power to the unit is off. Position the lamp surround below the unit so that the two pins on the underside line up with the two holes in the flange. The cover is designed to snap onto the housing flange (Fig 7) which sits flush against the ceiling.

Insert the five lamps into the sockets, tightening well to ensure good electrical contact and long life. Wipe the surround and the bulbs clean. Connect the power and check all functions.

Wiring:

Four switches on an Excel Life wall plate are supplied. Do not use with any solid state speed control.

Wall plate should be located so that the switches are not within reach of a person in a bath or a shower. Wiring connection is as per Figure 8.

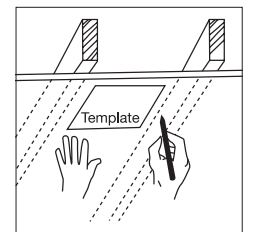

Fig 5

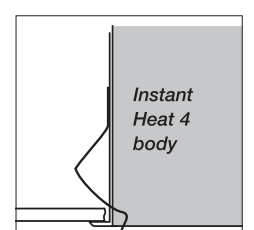

Fig 6

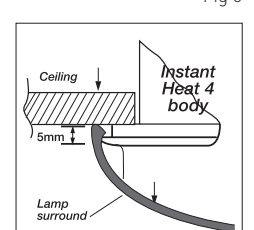

Fig 7

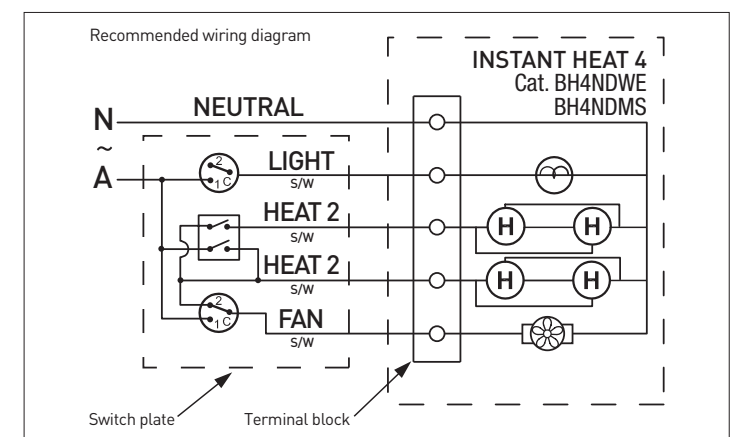

Fig 8. Wiring diagram

This product should be installed by a licensed electrical contractor or similarly qualified person.



Instant Heat 3-in-1

Non-Ducted 4 Heat Lamps
Cat BH4NDWE / BH4NDMS

Instruction Manual

Maintenance:

Cleaning:

- 1 Isolate the Instant Heat from the 240V supply. Ensure the lamps are cool to touch before handling.
- 2 Wipe lamps and fascia with care using a soft cloth soaked with a neutral detergent.

Lamp Replacement:

- 1 Isolate the Instant Heat from the 240V supply. Ensure the lamps are cool to touch before handling.
- 2 Replace LED light globe with HPM Cat No LR804K or E27 R80 100W max equivalent.
- 3 Replace heat lamp with HPM Cat No: L275HLES or E27 275W max equivalent (Not suitable for use with 375W heat lamps)

Specifications:

Supply voltage:	230-240V ac 50Hz
Max. power rating:	1240W
Airflow:	390m ³ /hr max [#]
Ceiling cut-out:	322 x 322mm
Projection into ceiling:	205mm
Required ceiling depth:	500mm
Facia protrusion:	25mm
Heat lamps:	4 x 275W
LED centre light:	7W R80 600lm
Weight:	4.5kG

[#] Airflow dependant on installation conditions

Parts Supplied:

Instant Heat	1 piece
Infra-red heat lamp (275W)	4 pieces
LED centre lamp (7W)	1 piece
Wall switch plate	1 piece
Installation instructions/template	1 piece

WARNING:

1. Use the Instant Heat only as described in this instruction. Other use not recommended by HPM Legrand may cause fire or electric shock.
2. This appliance is not intended for use by persons (including children) with reduced physical, sensory or mental capabilities, or lack of experience and knowledge, unless they have been given supervision or instruction concerning use of the appliance by a person responsible for their safety. Children should be supervised to ensure that they do not play with the appliance.
3. This appliance is intended for household use and similar purposes. It is not suitable for use in an environment heavily-laden with dust. Under these conditions the life of the fan motor can be significantly reduced.
4. All wiring must be carried out by a licensed electrician in accordance with applicable national/local codes and standards.
5. The lamps are hot when in use. Do not touch the infrared lamps with any part of your body when in use. Allow all lamps to cool sufficiently before touching or replacing.
6. For indoor use only
7. This product contains no serviceable parts and no attempt should be made to repair this product. If the product is faulty it should be discarded.
8. This product must be cleaned periodically from dust and other contaminants with a damp cloth. Cleaning agents and solvents should never be used.
9. Airflows listed in this product indicate the product performance. Refer to the BCA (Building Code of Australia), or similar, for the appropriate number of room air changes required for a particular installation.
10. This product has been designed to operate in ambient temperatures between 5°C to 40°C.
11. Consideration must be taken in the installation of ducts to ensure that condensation that will form in the duct will not run back in to the fan housing.
12. Ventilation products must have an adequate source of external air to ensure rated performance can be achieved.
13. This product should not be enclosed in thermal insulation as it may cause the unit to overheat.
14. The lamps on this product should be tightened until fit is secure. Over tightening may damage the lamp and under tightening may result in hot joints.

15. The terminals on this product should be tightened between 0.4Nm and 0.6Nm. Over tightening may damage the product. Under tightening may result in hot joints.
16. This product is not suitable for installation in hazardous and/or corrosive areas.
17. This product has been designed for domestic or similar uses and is not suitable for a commercial installation.
18. The material in this product may vary in colour from batch to batch. Colour matching from one batch to another cannot be guaranteed.
19. This product has been designed to operate on a nominal supply voltage of 230V -240Va.c. ± 6%.
20. After installation this product must be tested as required by the appropriate government and/or statutory regulations.
21. This product utilises intellectual property in the form of registered designs, trademarks, and/or patents. Such intellectual property remains the property of HPM Legrand in all cases.
22. HPM Legrand reserves the right to modify the specification of this product at any time.

Warranty:

HPM Legrand warrants the following on the Instant Heat from the date of purchase:

- 5-year warranty on materials and workmanship (excluding heat lamps and LED centre light).
- 2-year warranty on heat lamps and LED centre light.

These goods come with guarantees that cannot be excluded under the Australian Consumer Law. You are entitled to a replacement or a refund for a major failure and for compensation for any other reasonably foreseeable loss or damage. You are also entitled to have the goods repaired if the goods fail to be of acceptable quality and the failure does not amount to a major failure.

See the Warranty card enclosed with this product for further details.

LE06397AHA

For all Customer Service and Technical Support please call Monday to Friday during business hours.

HPM Legrand Australia
1300 369 777
www.hpmlegrand.com.au
ABN: 31 000 102 661