

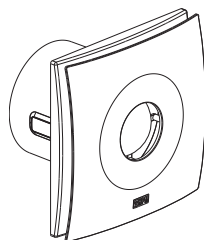

# Wall Exhaust Fan, 100mm

Cat. EF100SQWE, EF100SQSWE,  
EF100RDWE, EFT100SQSWE

## Instruction Manual



EF100SQWE  
Standard square  
100mm wall fan

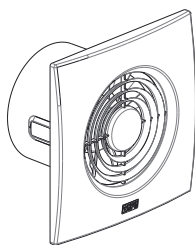

EF100SQSWE, \*EFT100SQSWE  
Slimline square 100mm wall  
fan and option with  
\*timer intergrated

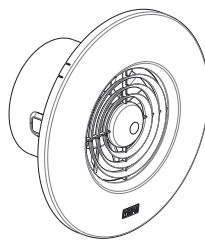

EF100RDWE  
Round  
100mm wall fan

**Please read carefully:** Read through these instructions completely before commencing installation. Retain for future use. This product should be installed by a licensed electrical contractor or similarly qualified person.

### 1 Product Specifications

Model	EF100SQWE	EF100SQSWE EFT100SQSWE	EF100RDWE
Supply Voltage	230-240VAC 50Hz		
Power Rating	14W		
Standby Power	0.8W (EFT100SQSWE)		
Wall Cut-out Size	Ø110mm		
Class of Protection	Class II		
IP Rating	IP44	IP24	IP24
Fascia	Size	158x158mm	158x158mm
	Protrusion	30mm	17mm
Weight (excl packaging)	500g	450g	450g

### Contents

Model	EF100SQWE	EF100SQSWE EFT100SQSWE	EF100RDWE
Exhaust Fan	1 pc	1 pc	1 pc
Draft Stopper	1 pc	1 pc	1 pc
Instruction Manual	1 pc	1 pc	1 pc
Warranty Card	1 pc	1 pc	1 pc
Wall Mount screws & Plugs	1 set	1 set	1 set

### Airflow\* (m<sup>2</sup>/hr)

Model	EF100SQWE		EF100SQSWE EF100RDWE EFT100SQSWE	
	with	without	with	without
No duct	68	94	81	105
Wall kit R621/4D* (350mm of duct)	33	68	48	75
1m of duct*	33	60	46	66

For indoor use only.

\*Measured with Φ100mm ducting.

Airflow will be reduced with bends in duct, squashing of duct, restrictions on replacement air entering the room to be ventilated, or pressure-differentials between the room and outside air. The length of the duct will have an effect on the airflow. When fitted, the wall kit (R621/4D) must be at the same height or lower than the exhaust fan.

### 2 Mounting

These exhaust fans are designed for wall-mounting only. They may be vented in to a cavity wall. Alternatively, the fan may be ducted through an outside wall (with the addition of ducting and an outside grille). Protrusions into wall cavity are as per below figures.

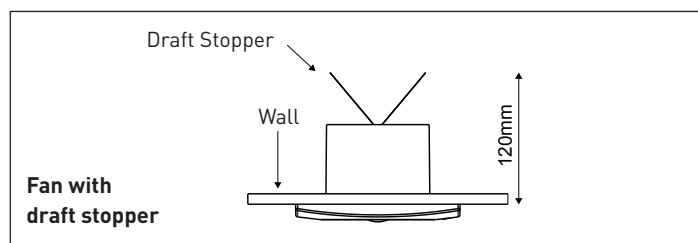
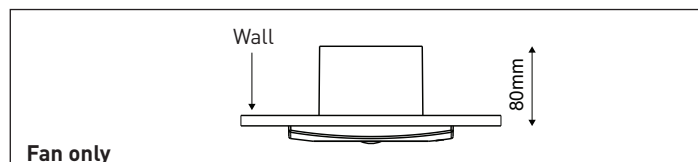

### CAUTION:

Regulations concerning the discharge of air must be fulfilled. Local building codes may require venting to the outside. Locate in accordance with the requirements of the Wiring Rules AS/NZS 3000 relating to damp situations.

Note: Steam will only be removed if there is sufficient flow of air through the room. Ensure adequate inlet openings in the room are provided, for example through windows, vents or under the door. Air-flow paths from room inlets to fan should ideally pass over surfaces where condensation may form.

### 3 Installation

Remove all packaging from the product before commencing installation. Ensure the circuit has been isolated from the 240V mains before commencing work.

1. Choose a suitable mounting location. There must be adequate clearances in the wall to accommodate the Draft-stopper and/or ducting. Refer to section 2 for further information.
2. If ducting through the wall to the outside, refer to instructions in the wall duct kit. Note: the wall kit is available separately, please refer to Optional Accessories section.
3. The time delay module that is included in EFT100SQSWE is available separately (EF100/150TD), adjustable from 1-to-29 minutes.
4. Make a circular 110mm hole in the wall.
5. Remove front cover / fascia by removing fixing screw and cap on the underside of the cover.
6. Remove draft-stopper if not required. Note that the draft-stopper (when fitted) has an effect on the airflow.
7. Make the electrical connections (as per Figures below).

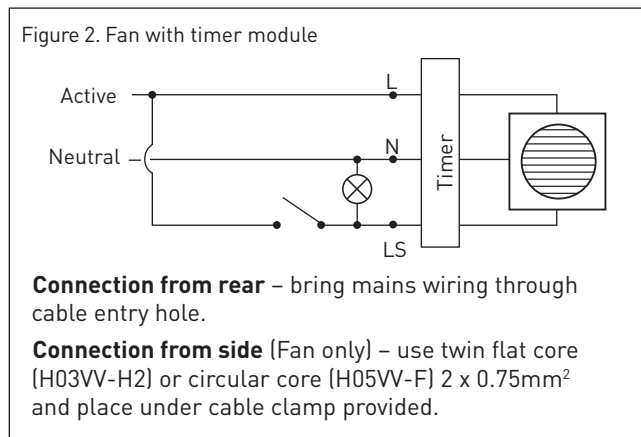
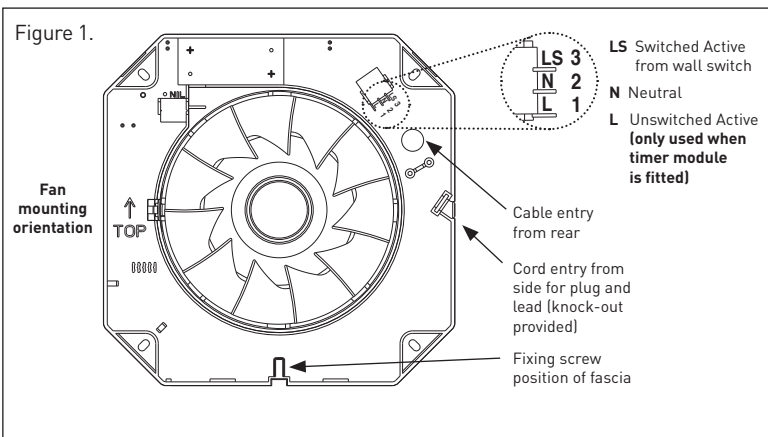

8. Ensure orientation of fan is with arrow pointing ↑ up.
9. Fix fan firmly to the wall with the 4 screws provided.
10. Replace front cover/fascia and tighten fixing screw. Replace cap.
11. Switch on and test function. Use a paper tissue held against fan inlet to verify suction.

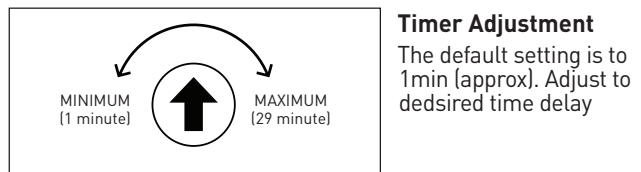

### 4 Cleaning

The exhaust fan grill should be cleaned every 6 months to prevent dust build-up. Ensure the fan is switched off from the mains supply before removing the fascia.

### 5 Optional Accessories

R621/4D – 100mm wall duct kit

EF100/150TD – Time delay module allows the fan to run for a set period, adjustable between 1 - 29 mins, after the switch has been turned off.

#### Disclaimers

1. This product must be installed and used as per these instructions. 2. This appliance is not intended for use by persons (including children) with reduced physical, sensory or mental capabilities, or lack of experience and knowledge, unless they have been given supervision or instruction concerning use of the appliance by a person responsible for their safety. Children should be supervised to ensure that they do not play with the appliance. 3. This appliance is intended for household use and similar purposes. It is not suitable for use in an environment heavily laden with dust. Under these conditions the life of the fan motor can be significantly reduced. 4. This product contains no serviceable parts and no attempt should be made to repair this product. If the product is faulty it should be discarded. 5. This product must be cleaned periodically from dust and other contaminants with a damp cloth. Aggressive cleaning agents and solvents should never be used. 6. Airflows listed in this product indicate the product performance. Refer to the BCA (Building Code of Australia), or similar, for the appropriate airflow required for a particular installation. 7. Ventilation products must have an adequate source of external air to ensure correct performance. 8. Consideration must be taken in the installation of ducts to ensure that condensation that will form in the duct will not run back in to the fan housing. 9. Precautions must be taken to avoid the back-flow of gases into the room from the open flue of gas or other fuel-burning appliances. 10. This product has been designed for domestic or similar uses and is not suitable for a commercial installation. 11. This product utilises intellectual property in the form of registered designs, trademarks, and/or patents. Such intellectual property remains the property of Legrand in all cases. 12. Legrand reserves the right to modify the specification of this product at any time.

#### Warranty

Legrand warrants this product for a period of 3 years from the date of purchase. These goods come with guarantees that cannot be excluded under the Australian and New Zealand Consumer Laws. You are entitled to a replacement or a refund for a major failure and for compensation for any other reasonably foreseeable loss or damage. You are also entitled to have the goods repaired if the goods fail to be acceptable quality and the failure does not amount to a major failure. See the Warranty card enclosed with this product for further details.

#### Customer Service

For all Customer Service and Technical Support please call Monday to Friday during business hours.

Legrand Australia  
1300 369 777  
www.hpm.com.au

Legrand New Zealand  
0800 476 009  
www.hpm.co.nz

ABN: 31 000 102 661