



A brand of **legrand**

Zyla Plus Flicker Free Recessed LED Downlight Tri-colour 90mm - White

Cat. No. **DLIFF90TRIDWE**

Instruction Manual

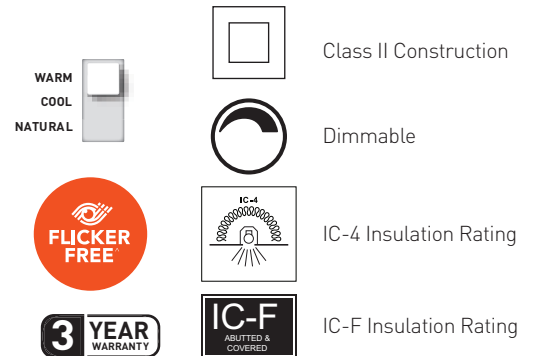
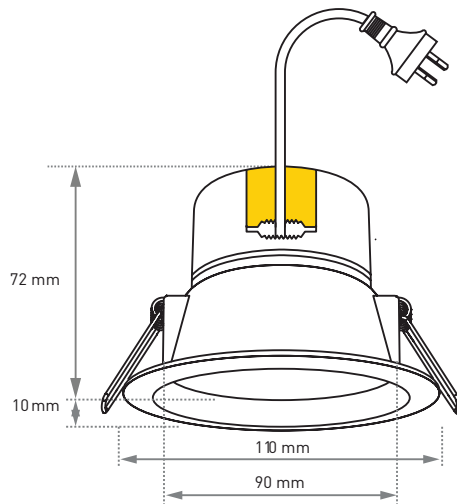

1 Product Specifications

Cat. No.	DLIFF90TRIDWE
Fascia Colour	White
Nominal Supply Voltage	230 - 240 V a.c 50 Hz
Power Input	7 W
Colour Rendering Index (CRI)	80+
Beam Angle	100°
Average Lifespan	35,000hrs*
Flicker Free	Both visible^ and invisible flickering
Dimmable	Yes - with Trailing Edge Dimmer
IP Rating	IP44 (Face only)
Ceiling Cut-out Size	Ø90 mm
Depth into Ceiling	72 mm
Fascia Size	Ø110 mm

LIGHT COLOUR vs LUMENS OUTPUT

Colour Temperature	Lumens Output	Efficacy
3000K (Warm White)	783 lm	110 lm/W
4000K (Cool White)	818 lm	115 lm/W
5000K (Natural White)	791 lm	113 lm/W

* Rated average lifespan in open air at 25°C, actual life will vary in individual circumstances.

^ Free of visible flickering for "ripple injection" up to 20 Vrms and an injection frequency up to 1050 Hz.

2 Installation

Please scan QR code to access the full installation instructions and technical information.



3 LED Downlight lamp life

35,000h Rated Average Lamp LED Life @ 25°C when installed with the default insulation clearances specified by AS/NZS 3000



20,000h Rated Average Lamp LED Life @ 25°C when installed with the thermal insulation abutting and covering the fixture in accordance with the IC-4 and IC-F rating specified in AS/NZS 60598.2.2

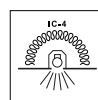

Note: This form of installation complies with the Wiring Rules AS/NZS 3000 requirement for recessed downlights, clause 4.5.2.3.1 (i).

Flicker Free

Visible Light flickering

This HPM LED downlight is specially designed to minimise the visible flickering of light output caused by "ripple control injection" (frequencies of 750 Hz and 1050Hz and up to 20 Vrms). This applies at both full brightness and when dimmed with approved HPM or Legrand dimmers.

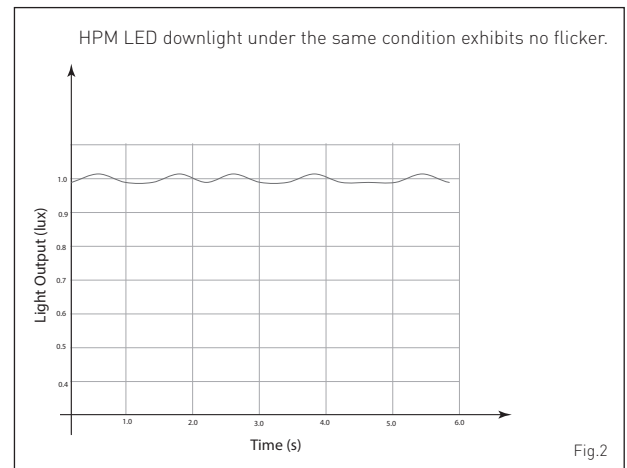
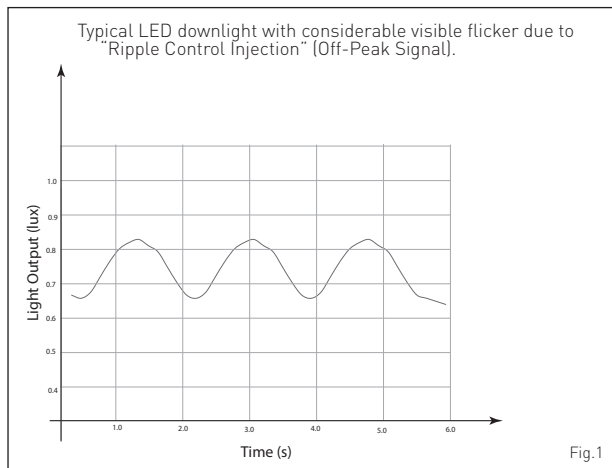

Invisible Light flickering

Most residential LED downlights have considerable invisible flickering at 100 Hz due to fluctuating DC driving current on LED chips as per the figure below (Fig.3). At this frequency, most people do not perceive with naked eye but it could cause health issues like eyestrain and headaches depending on the level of flickering.

This HPM LED downlight is specially designed with internal LED driver that output almost pure DC, even when dimmed to very low brightness (Fig.5). Hence, there is virtually not invisible flickering.

Examples of invisible light flickering waveforms.

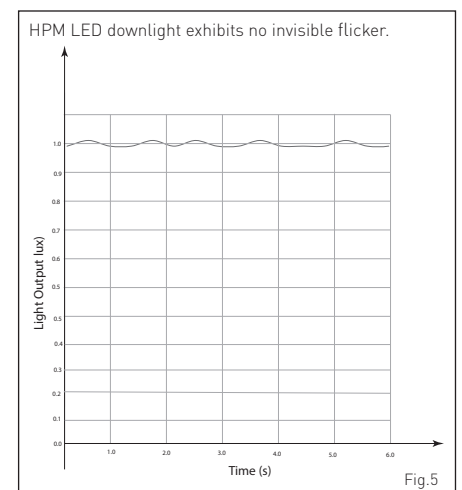
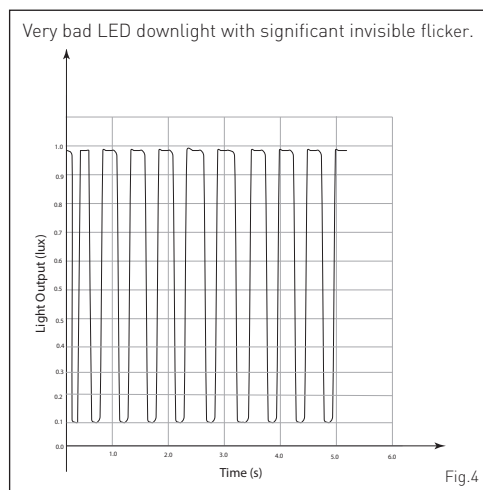
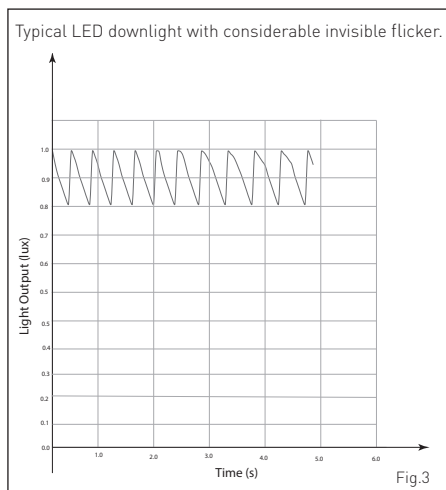

Product Notes

1. This product must be installed and used as per these instructions. **2.** This product should not be used by children or the infirm. **3.** An IP rating of IP44 is generally considered suitable for external walls with supplementary protection such as overhanging eaves. **4.** The IP rating of this product is only valid when installed on a flat and non-porous surface. Additional sealing may be required for irregular surfaces. The IP rating of this product is only valid when used with plugs complying with the IP requirements of AS/NZS 3123, IEC 60309, or AS/NZS 3112 as applicable. **5.** This product contains no serviceable parts and no attempt should be made to repair this product. If the supply cord is damaged it shall be replaced by a qualified person in order to avoid a hazard. **6.** This product is not suitable for installation in hazardous and/or corrosive areas. **7.** Electrical installations periodically receive transient over-voltages. This product has been designed to minimise the effect of such voltages on connected equipment. It may not give full protection for extreme over-voltage transients such as those resulting from a close lightning strike. **8.** This product is designed to mitigate the influence of ripple control frequencies used on the electricity supply network. There may be circumstances where flicker may be introduced by other sources of interference and cannot be discounted. **9.** Extended exposure to UV rays (such as exposure to direct sunlight) may cause discolouration of this product. **10.** The material in this product may vary in colour from batch to batch. Colour matching from one batch to another cannot be guaranteed. **11.** This product utilises intellectual property in the form of registered designs, trademarks, and/or patents. Such intellectual property remains the property of Legrand in all cases. **12.** Legrand reserves the right to modify the specification of this product at any time.

Warranty

- Legrand ("we or us") has given each purchaser who is a consumer ("you") a warranty against defects in its products.
- As a consumer, you are entitled to the benefit of the Warranty and should read and understand its terms. In addition, for the purposes of the Australian and New Zealand Consumer Laws, we note the following:
 - If we accept your claim under the Warranty we will reimburse all your reasonable expenses in making and pursuing the claim, including the cost of reimbursement of any defective products returned in the ordinary course to us at the address above by post or other agreed means. Any such claim must be made within 14 days of your receiving notice of our acceptance of your claim and include any necessary supporting documentation or invoices.
 - As a consumer, you have rights under the Australian and New Zealand Consumer Laws and may have rights under other applicable laws which cannot be excluded, restricted or modified. Those rights are in addition to any rights you have under the Warranty.
 - Legrand warrants this product for a period of 3 years from the date of purchase. Our goods (which we refer to in the Warranty as the Products) come with guarantees that cannot be excluded under the Australian and New Zealand Consumer Laws. You are entitled to a replacement or a refund for a major failure and compensation for any other reasonably foreseeable loss or damage. You are also entitled to have the goods repaired or replaced if the goods fail to be of acceptable quality and the failure does not amount to a major failure.

- Our contact details for the purpose of any claims made under the Warranty are below. Any claim under the Warranty must be sent in writing to the following address:

AUSTRALIA ONLY
Legrand Australia Pty Ltd
Nexus Industry Park
Bldg 4, 43-47 Lyn Parade
PRESTONS, NSW 2170
1300 369 777
sales.orders@legrand.com.au

NEW ZEALAND ONLY
Legrand New Zealand Ltd
106-124 Target Rd
GLENFIELD, AUCKLAND
0800 476 009
nz.sales@legrand.co.nz

