



A brand of  legrand®

# LED LIGHTING



BRIGHT  
STYLISH  
EFFICIENT

3rd EDITION

# CONTENTS

<b>LED LIGHTING EXPLAINED</b>	2
<b>LED LIGHTING FIXTURES</b>	4
DOWNLIGHTS	6
PANEL LIGHTS	20
OYSTER LIGHTS	22
INTERIOR UP/DOWN LIGHTS	26
STEP LIGHTS	30
STARLIGHTS	32
STRIPLIGHT	34
EXTERIOR UP/DOWN LIGHTS	36
OUTDOOR BUNKER LIGHT	42
FLOODLIGHTS	44
<b>WORKLIGHTS</b>	56
<b>LED LIGHTING GLOBES</b>	58
<b>DIMMERS AND LED COMPATIBILITY</b>	68
<b>DOWNLIGHT ACCESSORIES</b>	68
<b>LIGHTING SENSORS</b>	70
<b>INDEX OF PROTECTION</b>	71



# LED LIGHTING EXPLAINED

## LIGHT COLOUR

Expressed in Degrees Kelvin (K), light colours are the key to determining the mood of a room.

<b>WARM WHITE</b>	DEGREES	2700-3000K
	DESCRIPTION	<b>SOFTER, WARMER LIGHT</b> Comparable to traditional incandescent lighting. Preferred in cooler climates
	ROOM	Bedroom, living room, bathroom, kitchen
<b>COOL WHITE</b>	DEGREES	4000K
	DESCRIPTION	<b>NEUTRAL LIGHT</b> Used for task lighting and preferred in warmer, tropical climates
	ROOM	Laundry, garage, study, bathroom, kitchen

## AVERAGE LAMP LIFE

LED 30,000 HOURS	COMPACT FLUORESCENT 10,000 HOURS	INCANDESCENT 1,000 HOURS
------------------	----------------------------------	--------------------------

**DURABILITY:** LEDs are very long-lasting compared to other lighting technologies, with an average 30,000 hours life expectancy. We use quality components which make our lamps even more durable, being laboratory tested and assessed at 30,000 hours life expectancy. That represents approximately 20 years based on 3 to 4 hours usage per day.

## DIMMING COMPATIBILITY

Critical to a successful installation is an understanding of LED compatibility with dimmers.

HPM is one of the only major brands on the market to deliver a full solution from dimmers to drivers and LED fixtures. Choose the winning combination of HPM LED fixtures and HPM or Legrand dimmers to ensure superior performance – including smooth dimming with no flickering, reliability and long life.



## LIGHT PERFORMANCE

LIGHT OUTPUT	INCANDESCENT	HALOGEN	CFL	LED
220lm	25W	18W	5-7W	3W
420lm	40W	28W	7-8W	4-5W
720lm	60W	42W	11-12W	6-8W
930lm	75W	52W	13-18W	9-13W
1300lm	100W	70W	18-23W	16-20W

## LUMINOUS EFFICACY (lm/W)

Picking a lamp fixture based only on wattage or physical size could result in the wrong choice: Wattage (measured in W) represents the power consumed by the luminaire. The actual output of a lamp is measured in lumens (lm): the more lumens, the more light emitted by the luminaire. A smart criteria for determining the efficiency of a light fixture is its lumens/Watt ratio, which represents how much light the fixture delivers versus what it consumes to perform. This value is called luminous efficacy, and proves LED lights are more efficient than other light technologies.

## COLOUR RENDERING INDEX (CRI)

CRI measures how well a lamp makes colours appear. CRI scores light sources from 1 – 100: a high CRI means that the eye can pick up slight variations in colour, making details in an interior appear sharper and more vibrant. For outstanding colour rendering, opt for our Dalia series which boasts a very high 92 index.

Our downlights range from 80 to 92, to enhance skin tones, hues and textures in rooms.

## BEAM ANGLE

The light effect from a luminaire is determined by its beam angle, that is the shape and direction of light generated by the lamp. Most conventional fixtures deliver a focused light distribution at 35-60° beam angle, but LED technology can go well above those values, while still maintaining a fair pool of light.

Our lights deliver beam angles ranging from 80 to 120° to ensure a beautiful light is spread throughout a room.

## OUR QUALITY PROMISE



### DIMMING COMPATIBILITY

Yes! Our lights can be dimmed effectively. For optimum dimming performance and to avoid flickering, use HPM or Legrand dimmers. See p.69-70 for more details



### INSULATION RATING

All recessed luminaires included in this brochure have an IC or IC-4 insulation rating. This means insulation may abut or cover the LED luminaire



### NATA ACCREDITED LABORATORY

To ensure the highest possible quality assurance standards all HPM lighting fixtures and lamps are tested in our NATA accredited laboratory in Sydney



All our products are assured against insects and moisture, with IP ratings ranging from IP44 to IP65. See IP chart on p.71 for more information



# LED LIGHTING FIXTURES





# DLI DOWNLIGHT SERIES (5W TO 7W)

The functional design and classic finish of the DLI adds a touch of contemporary lighting. The DLI is ideal for all rooms in the house. At only 5W to 7W the DLI delivers maximum brightness with limited power consumption.



### Main applications

Living areas, bedrooms, bathrooms, outdoor areas (undercover)

### TIP

Recessed diffuser reduces glare



DLI70 SERIES



DLI90 SERIES



DLI125 SERIES

UP TO  
**880**  
LUMENS

IC-4  
INSULATION RATING

**IP44**  
WEATHERPROOF

**3 YEAR**  
WARRANTY

Power		5W	7W	7W
Lumen output		<b>70mm</b>	<b>90mm</b>	<b>125mm</b>
	Warm White	505lm	700lm	750lm
	Cool White	515lm	820lm	880lm
Efficacy		<b>70mm</b>	<b>90mm</b>	<b>125mm</b>
	Warm White	101lm/W	100lm/W	107lm/W
	Cool White	103lm/W	117lm/W	125lm/W
Colour temperature	Warm White			3,000K
	Cool White			4,000K
CRI	80+			
Dimming	Trailing edge dimmers			
Lifespan	35,000h			
Package contents	5W to 7W dimmable downlight with integrated driver. Supplied with flex and plug			

Product codes	Ø70mm cut-out	
	White Fascia	
	Warm White Light	<b>DLI7001</b>
	Cool White Light	<b>DLI7002</b>
	Brushed Chrome Fascia	
	Warm White Light	<b>DLI7003</b>
	Cool White Light	<b>DLI7004</b>
	Ø90mm cut-out	
	White Fascia	
	Warm White Light	<b>DLI9001</b>
	Cool White Light	<b>DLI9002</b>
	Brushed Chrome Fascia	
	Warm White Light	<b>DLI9003</b>
	Cool White Light	<b>DLI9004</b>
	Ø125mm cut-out	
	White Fascia	
	Warm White Light	<b>DLI12501</b>
	Cool White Light	<b>DLI12502</b>

### DLI70 Series

BEAM  
ANGLE 90°

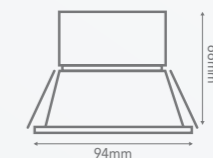

### DLI90 Series

BEAM  
ANGLE 85°

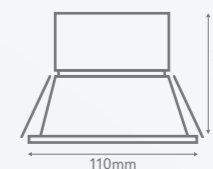

### DLI125 Series

BEAM  
ANGLE 90°

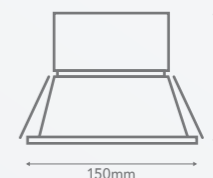

# AZA+ DOWNLIGHT SERIES (8W)

The AZA+ sits flush with the ceiling blending seamlessly with any décor and provides bright and energy saving illumination.



### Main applications

Living areas, bedrooms, bathrooms, outdoor areas (undercover)

### TIP

At only 65mm depth, AZA+ downlights will fit in most ceiling cavities



<b>Power</b>	8W	
<b>Lumen output</b>	Warm White	750lm
	Cool White	820lm
<b>Efficacy</b>	Warm White	93lm/W
	Cool White	102lm/W
<b>Colour temperature</b>	Warm White	3,000K
	Cool White	4,000K
<b>CRI</b>	80+	
<b>Dimming</b>	Trailing edge dimmers	
<b>Lifespan</b>	35,000h	
<b>Package contents</b>	8W dimmable downlight with integrated driver. Supplied with flex and plug	

<b>Product codes</b>	White Fascia	
	Warm White Light	<b>LDL043KWE</b>
	White Fascia	
	Cool White Light	<b>LDL044KWE</b>
	Polished Silver Fascia	
	Warm White Light	<b>LDL043KPS</b>
	Polished Silver Fascia	
	Cool White Light	<b>LDL044KPS</b>

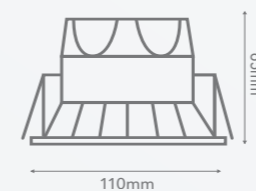

# DALIA

DOWNLIGHT SERIES (15W)

Equipped with a Citizen LED chip, these superior downlights are our brightest and deliver exceptional colour rendering, making details in an interior space appear sharper and more vibrant. Dalia is a fusion of craftsmanship, highest-calibre materials and advanced technology. Available in white or polished aluminium.



### Main applications

Living areas, bedrooms, bathrooms, outdoor areas (undercover)



### TIP

With an outstanding 92+ CRI, Dalia downlights illuminate objects and surfaces in their true colours

<b>Power</b>	15W	
<b>Lumen output</b>	Warm White	950lm
	Cool White	980lm
<b>Efficacy</b>	Warm White	63lm/W
	Cool White	65lm/W
<b>Colour temperature</b>	Warm White	3,000K
	Cool White	4,000K
<b>CRI</b>	92+	
<b>Dimming</b>	Trailing & leading edge, 2 & 3 wire	
<b>Lifespan</b>	30,000h	
<b>Construction</b>	Corrosion resistant anodised aluminium	
<b>Package contents</b>	Dimmable SELV external LED driver and 15W LED sealed fixture. Supplied with flex and plug	
<b>Product codes</b>	White Fascia	
	Warm White Light	<b>LDL023KWE</b>
	Cool White Light	<b>LDL024KWE</b>
	Aluminium Fascia	
	Warm White Light	<b>LDL023KPS</b>
	Cool White Light	<b>LDL024KPS</b>

BEAM ANGLE 80°

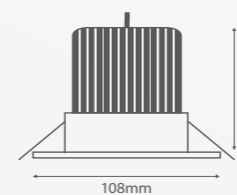

85-90 MM CUT-OUT

UP TO 980 LUMENS



IP44 WEATHERPROOF

6 YEAR WARRANTY





# AZALEA DOWNLIGHT SERIES (9W)



A marriage of style and function, our Azalea effortlessly achieves optimum lighting performance with impressive economy. With a 48mm depth, it is brilliant for tight ceiling cavities and multi-floor dwellings.

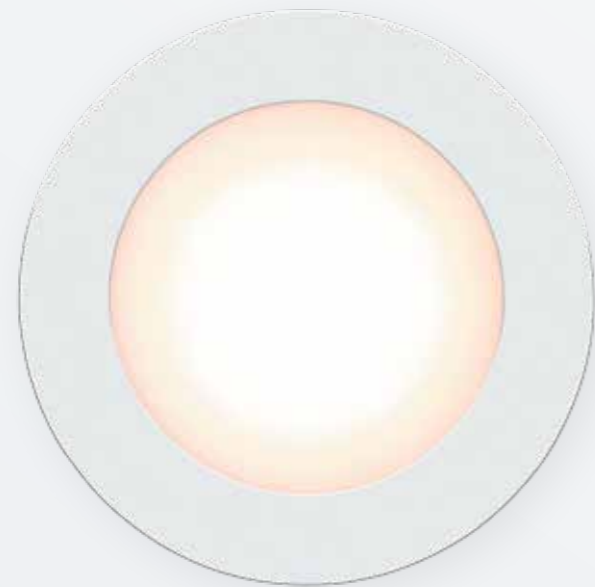

### Main applications

Living areas, bedrooms, bathrooms, outdoor areas (undercover)



UP TO  
**890**  
LUMENS

IC-4  
INSULATION RATING

**IP44**  
WEATHERPROOF

**6 YEAR**  
WARRANTY

<b>Power</b>	9W	
<b>Lumen output</b>	Warm White	880lm
	Cool White	890lm
<b>Efficacy</b>	Warm White	98lm/W
	Cool White	99lm/W
<b>Colour temperature</b>	Warm White	3,000K
	Cool White	4,000K
<b>CRI</b>	80+	
<b>Dimming</b>	Trailing & leading edge, 2 & 3 wire	
<b>Lifespan</b>	30,000h	
<b>Construction</b>	Aluminium	
<b>Package contents</b>	Dimmable SELV external LED driver and 9W LED sealed fixture. Supplied with flex and plug	
<b>Product codes</b>	White Fascia	
	Warm White Light	<b>LDL013KWE</b>
	White Fascia	
	Cool White Light	<b>LDL014KWE</b>
	Aluminium Fascia	
	Warm White Light	<b>LDL013KPS</b>
	Aluminium Fascia	
	Cool White Light	<b>LDL014KPS</b>

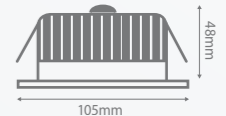

# DLS DOWNLIGHT SERIES (10W)

Behind the stylish façade of white or brushed chrome, the DLS features a frosted recessed diffuser to reduce glare and ensure a perfect light spread across any room. Our vision, improving your vision.



### Main applications

Living areas, bedrooms, bathrooms, outdoor areas (undercover)

### TIP

Recessed diffuser reduces glare



<b>Power</b>	10W	
<b>Lumen output</b>	Warm White	800lm
	Cool White	830lm
<b>Efficacy</b>	Warm White	80lm/W
	Cool White	83lm/W
<b>Colour temperature</b>	Warm White	3,000K
	Cool White	4,000K
<b>CRI</b>	80+	
<b>Dimming</b>	Trailing edge dimmers	
<b>Lifespan</b>	30,000h	
<b>Package contents</b>	Dimmable SELV external LED driver with quick-connect plug and 10W LED sealed fixture. Supplied with flex and plug	

<b>Product codes</b>	White Fascia	
	Warm White Light	<b>DLS9001</b>
	White Fascia	
	Cool White Light	<b>DLS9002</b>
	Brushed Chrome Fascia	
	Warm White Light	<b>DLS9003</b>
	Brushed Chrome Fascia	
	Cool White Light	<b>DLS9004</b>

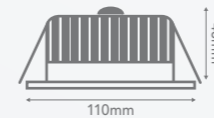

# FREESIA DOWNLIGHT SERIES (7W)



The diminutive Freesia series delivers a big performance with a minimal footprint. Available in both white or polished aluminium, it is ideal for retrofitting halogen lights with 70mm hole cut-outs.



### Main applications

Living areas, bedrooms, bathrooms, outdoor areas (undercover)

### TIP

Freesia's 70mm cut-out makes it an ideal upgrade of fixed halogen downlights

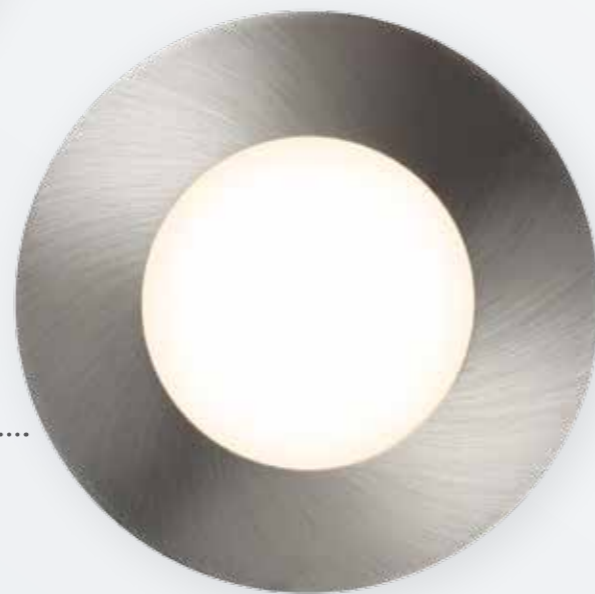

**500 LUMENS\***

IC-4 INSULATION RATING

**IP44 WEATHERPROOF**

**6 YEAR WARRANTY**

<b>Power</b>	7W	
<b>Lumen output</b>	Warm White	600lm
	Cool White	620lm
<b>Efficacy</b>	Warm White	86lm/W
	Cool White	89lm/W
<b>Colour temperature</b>	Warm White	3,000K
	Cool White	4,000K
<b>CRI</b>	80+	
<b>Dimming</b>	Trailing & leading edge, 2 & 3 wire	
<b>Lifespan</b>	30,000h	
<b>Construction</b>	Aluminium	
<b>Package contents</b>	Dimmable SELV external LED driver and 7W LED sealed fixture. Supplied with flex and plug	
<b>Product codes</b>	White Fascia	
	Warm White Light	<b>LDL033KWE</b>
	White Fascia	
	Cool White Light	<b>LDL034KWE</b>
	Aluminium Fascia	
	Warm White Light	<b>LDL033KPS</b>
	Aluminium Fascia	
	Cool White Light	<b>LDL034KPS</b>

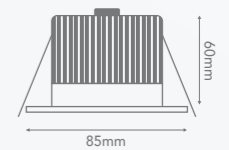



# MR16 RETROFIT DOWNLIGHT SERIES (7W TO 9W)



This patented energy efficient MR16 retrofit LED downlight has been designed as a DIY upgrade to existing MR16 halogen downlights. Compatible with all leading brands of transformers on the market, choose this simple and safe solution for great light output and energy saving.



**Main applications**  
DIY Replacement of existing halogen MR16 downlights.

**TIP**

Compatible with all leading brands of transformers on the market.



UP TO  
**770**  
LUMENS

**D.I.Y.**  
INSTALL IT  
YOURSELF

**IP44**  
WEATHERPROOF

**3 YEAR**  
WARRANTY

<b>Power</b>		7W	9W
<b>Lumen output</b>	Warm White	550	710lm
	Cool White	590	770lm
<b>Efficacy</b>	Warm White	78lm/W	78lm/W
	Cool White	84lm/W	85lm/W
<b>Colour temperature</b>	Warm White		3,000K
	Cool White		4,000K
<b>Insulation rating</b>	Ø90mm 9W IC abutted & covered Ø70mm 7W CA90 abutted only		
<b>CRI</b>	80+		
<b>Lifespan</b>	35,000h		
<b>Package contents</b>	MR16 LED downlight		

<b>Product codes</b>	<b>Ø70mm cut-out 7W</b>	
	White Fascia	<b>LMR16703KWE</b>
	Warm White Light	<b>LMR16704KWE</b>
	Cool White Light	<b>LMR16704KWE</b>
	<b>Ø90mm cut-out 9W</b>	
	White Fascia	<b>LMR16903KWE</b>
	Warm White Light	<b>LMR16904KWE</b>
	Cool White Light	<b>LMR16904KWE</b>

**Install it yourself in 3 easy steps.**

**1. Remove.**

Unplug and remove existing MR16 halogen downlight.

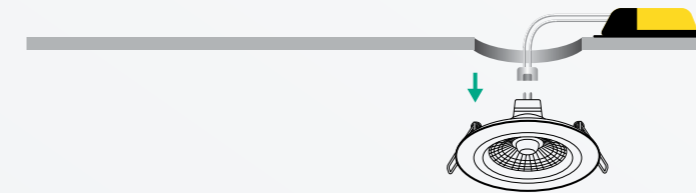

**2. Replace.**

Plug-in your new HPM MR16 LED downlight and install back into ceiling.

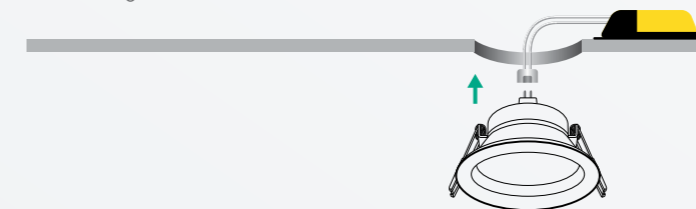

**3. Ready.**

Enjoy great light output, sleek design and up to 80% energy saving.

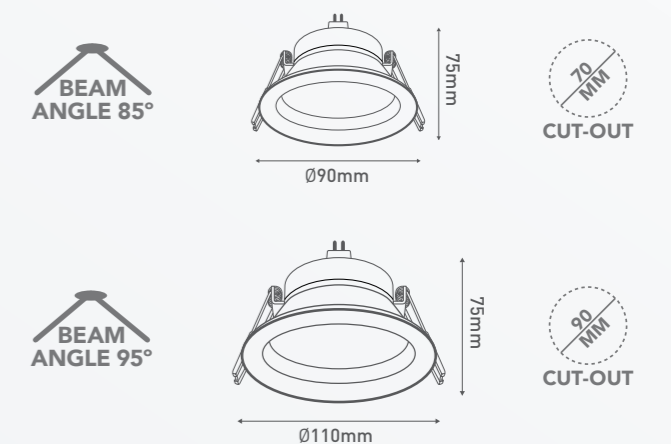
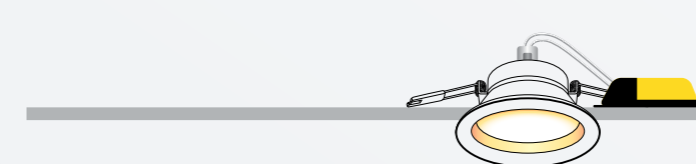

# LUNA

PANEL LIGHTS (18W)

Offering the ultimate in discreet lighting, the Luna's slim depth allows it to fit effortlessly into tight ceiling cavities. All the illumination of an oyster light, none of the obtrusiveness.

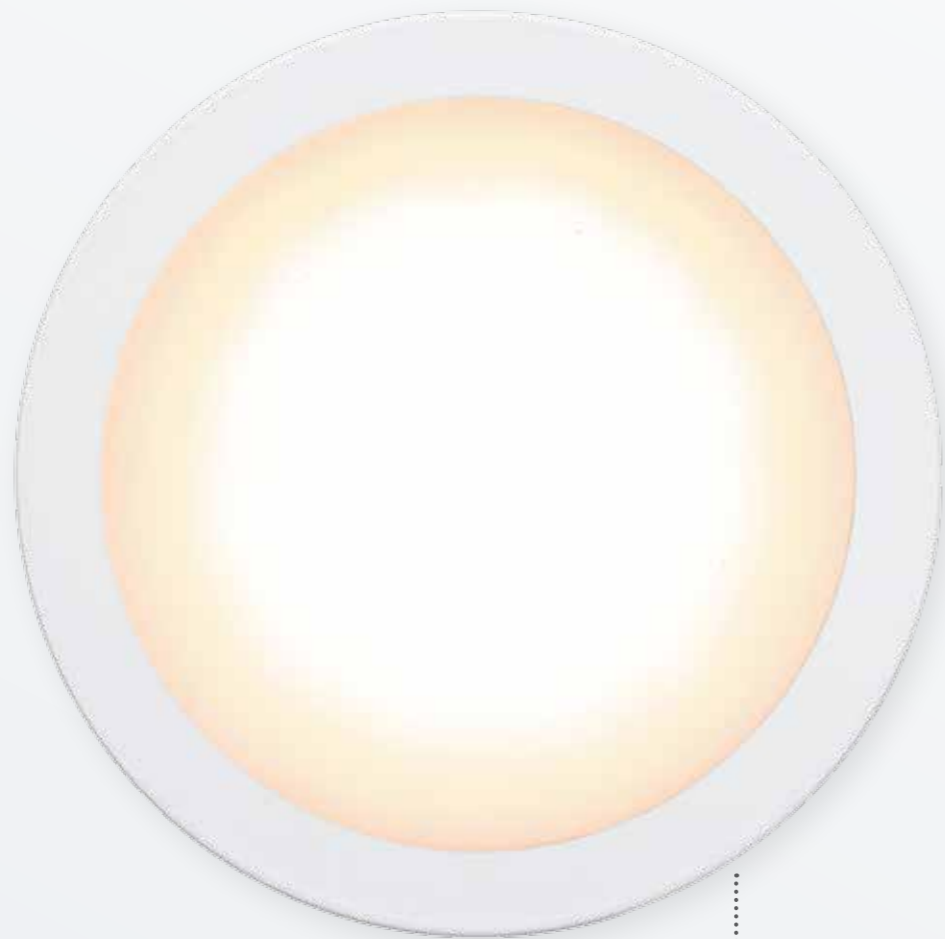

#### Main applications

Living areas, bedrooms, bathrooms, and undercover outdoor areas.  
Ideal replacement for oyster lights

<b>Power</b>	18W	
<b>Lumen output</b>	Warm White	1,440lm
	Cool White	1,500lm
<b>Efficacy</b>	Warm White	80 lm/W
	Cool White	83 lm/W
<b>Colour temperature</b>	Warm White	3,000K
	Cool White	4,000K
<b>CRI</b>	80+	
<b>Dimming</b>	Trailing & leading edge, 2 & 3 wire	
<b>Lifespan</b>	30,000h	
<b>Construction</b>	Aluminium	
<b>Package contents</b>	Dimmable SELV external LED driver and 18W LED sealed fixture. Supplied with flex and plug	
<b>Product code</b>	White Fascia	
	Warm White Light	<b>LPA013KWE</b>
	White Fascia	
	Cool White Light	<b>LPA014KWE</b>

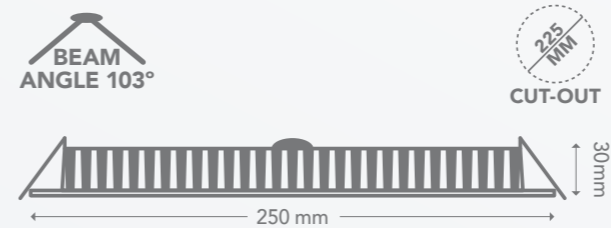

UP TO 1500 LUMENS

INSULATION RATING

IP44 WEATHERPROOF

6 YEAR WARRANTY



# ATIS OYSTER LIGHTS (17W)

The Atis brings a touch of simple elegance to any room. Providing evenly distributed ambient light from the ceiling makes it the ideal light for task, general or accent lighting.



### Main applications

Living areas, bedrooms, bathrooms, and undercover outdoor areas.

<b>Power</b>	17W	
<b>Lumen output</b>	Warm White	1,650lm
	Cool White	1,750lm
<b>Efficacy</b>	Warm White	98lm/W
	Cool White	104lm/W
<b>Colour temperature</b>	Warm White	3,000K
	Cool White	4,000K
<b>CRI</b>	80+	
<b>Dimming</b>	Trailing edge dimmers	
<b>Lifespan</b>	30,000h	
<b>Construction</b>	Metal base with polycarbonate lens	
<b>Package contents</b>	17W LED dimmable oyster light, wall plugs and screws	
<b>Product code</b>	White Finish Warm White Light	<b>LOL013KWE</b>
	White Finish Cool White Light	<b>LOL014KWE</b>

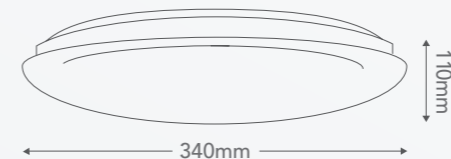

Dimmable





# AURA OYSTER LIGHTS (18W)



With a simple unobtrusive design the Aura provides a pleasant, evenly distributed light that is ideal in larger living areas.



**Main applications**

Living areas, bedrooms, bathrooms

<b>Power</b>	18W	
<b>Lumen output</b>	Warm White	1,520lm
	Cool White	1,550lm
<b>Efficacy</b>	Warm White	84lm/W
	Cool White	86lm/W
<b>Colour temperature</b>	Warm White	3,000K
	Cool White	4,000K
<b>CRI</b>	80+	
<b>Dimming</b>	Trailing & leading edge, 2 & 3 wire	
<b>Lifespan</b>	24,000h	
<b>Construction</b>	Metal base with silver trim and plastic diffuser	
<b>Package contents</b>	18W LED dimmable oyster light, wall plugs and screens	
<b>Product code</b>	White Fascia Warm White Light	<b>L0L023KPS</b>
	White Fascia Cool White Light	<b>L0L024KPS</b>



Dimmable



BEAM  
ANGLE 105°

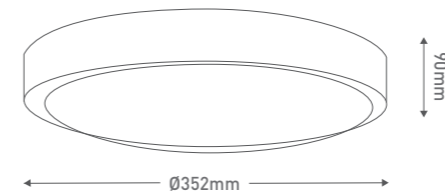

# KORA INTERIOR UP/DOWN LIGHT (8.3W)

Kora throws light both up and down to create a beautiful light pattern on walls and imbue rooms with convivial ambience. The stylish cube design will complement contemporary interiors starring clean lines.

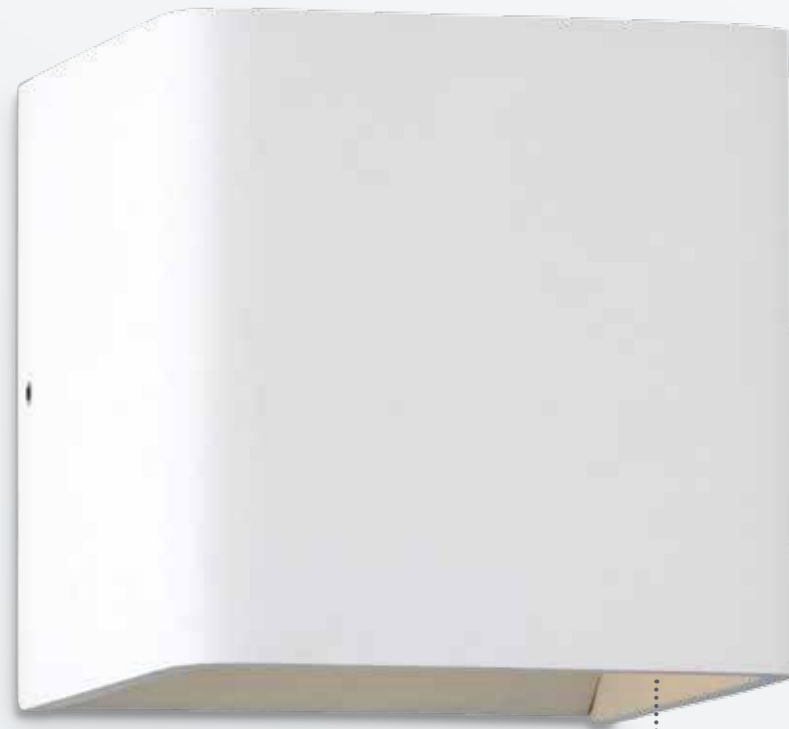

↑  
Light flows both  
up and down  
↓

#### Main applications

Living areas, hallways, entrances

<b>Power</b>	8.3W
<b>Lumen output</b>	Warm White 335lm
<b>Efficacy</b>	Warm White 40lm/W
<b>Colour temperature</b>	Warm White 3,000K
<b>CRI</b>	80+
<b>Lifespan</b>	30,000h
<b>Construction</b>	Anodised aluminium with white finish
<b>Package contents</b>	8.3W LED up/down light fixture, wall plugs and screws
<b>Product code</b>	White Finish Warm White Light <b>LWL053KWE</b>

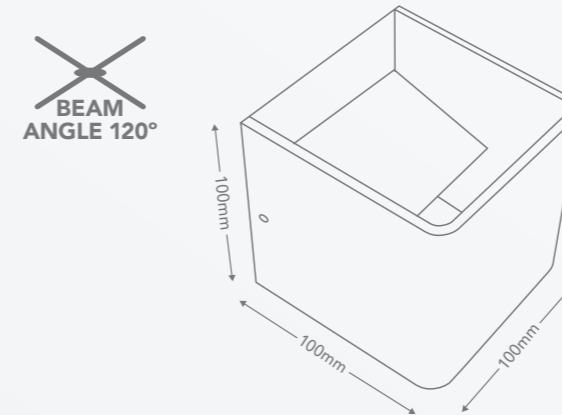

335  
LUMENS

UP DOWN  
LIGHT BEAM

6 YEAR  
WARRANTY



# DIAMA

INTERIOR UP/DOWN LIGHT (7.5W)

Transform walls into a visual feast with a Diama fixture. With its unique two-directional light beam, Diama is the perfect light for enhancing architecture.



↑  
Light flows both  
up and down  
↓



**TIP**

Combine this architectural light with Legrand Arteor switches and sockets to create a genuine feel of interior elegance and refinement

**Main applications**

Living areas, hallways, entrances

<b>Power</b>	7.5W	
<b>Lumen output</b>	Warm White	520lm
<b>Efficacy</b>	Warm White	69lm/W
<b>Colour temperature</b>	Warm White	3,000K
<b>CRI</b>	80+	
<b>Lifespan</b>	30,000h	
<b>Construction</b>	Anodised aluminium with high gloss white finish	
<b>Package contents</b>	7.5W LED up/down light fixture, wall plugs and screws	
<b>Product code</b>	White Finish Warm White Light	<b>LWL033KWE</b>

**BEAM ANGLE 120°**

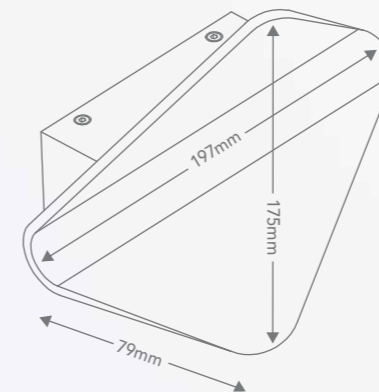

**520 LUMENS**

**UP DOWN LIGHT BEAM**

**6 YEAR WARRANTY**





# CALLA STEP LIGHTS (2.4W)

Scale the heights of style with Calla step lights, an illuminating choice for stairwells or hallways. Whether indoor or outdoor, the Calla excels with its impressive IP65 weatherproof rating.

### Main applications

Stairs, hallways, corridors



### TIP

Use every second or third step, approximately 300-350mm above floor level, for the ultimate light spread



<b>Power</b>	2.4W	
<b>Lumen output</b>	Warm White	24lm
<b>Efficacy</b>	Warm White	10lm/W
<b>Colour temperature</b>	Warm White	3,000K
<b>CRI</b>	80+	
<b>Dimming</b>	Trailing & leading edge, 2 & 3 wire	
<b>Lifespan</b>	30,000h	
<b>Construction</b>	Corrosion resistant anodised aluminium	

<b>Weatherproof rating</b>	IP65	
<b>Package contents</b>	2.4W LED step light fixture	
<b>Product codes</b>	White Finish Warm White Light	<b>LST013KWE</b>
	Aluminium Finish Warm White Light	<b>LST013KPS</b>
	Driver Kit	<b>LDR02D700/18</b>

**Installation** Must be installed with driver kit LDR02D700/18. A minimum of 2 and a maximum of 6 step lights must be connected with each driver. Step lights must be connected in series.

<b>Driver kit contents LDR02D700/18</b>	Plug, lead, driver
	900mm DRIVER 100mm
	Plug coupler (x2)  100mm
	Socket coupler (x2)  100mm
	Jumper (x1)  300mm

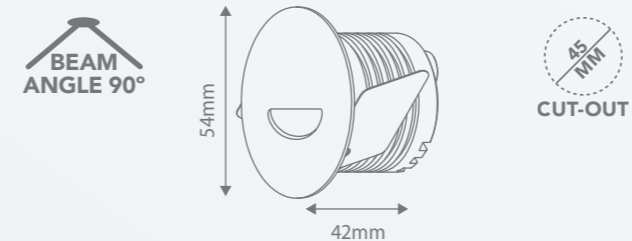

# ZINNIA STARLIGHTS (2.4W)

A fusion of discretion and efficiency, the Zinnia starlights are an in vogue choice for those with an eye for detail. Whether illuminating under cabinets or wall features, indoors or outdoors, the Zinnia is the epitome of versatile style. Available in white and silver. Weatherproof rated IP65.

### Main applications

Under cabinets, alfresco areas, home theatres. Ideal for illuminating features and creating ambience



### TIP

With a slim 35mm depth, Zinnia fits into almost any wall or ceiling cavity



<b>Power</b>	2.4W	
<b>Lumen output</b>	Warm White	95lm
<b>Efficacy</b>	Warm White	39lm/W
<b>Colour temperature</b>	Warm White	3,000K
<b>CRI</b>	80+	
<b>Dimming</b>	Trailing & leading edge, 2 & 3 wire	
<b>Lifespan</b>	30,000h	
<b>Construction</b>	Corrosion resistant anodised aluminium	
<b>Weatherproof rating</b>	IP65	
<b>Package contents</b>	2.4W LED starlight fixture	
<b>Product codes</b>	White Finish Warm White Light	<b>LST023KWE</b>
	Aluminium Finish Warm White Light	<b>LST023KPS</b>
	Driver Kit	<b>LDR02D700/18</b>

**Installation** Must be installed with driver kit LDR02D700/18. A minimum of 2 and a maximum of 6 starlights must be connected with each driver. Starlights must be connected in series.

### Driver kit contents LDR02D700/18

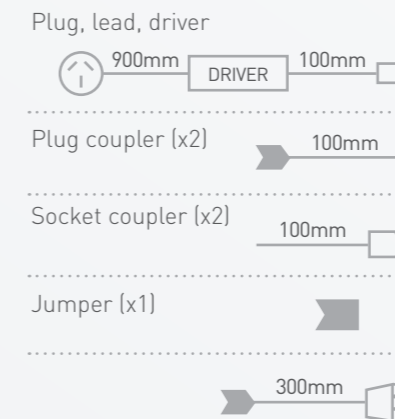

BEAM ANGLE 45°

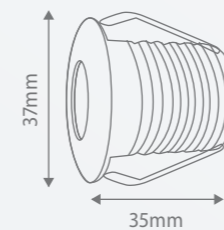

32MM CUT-OUT

95 LUMENS



IP65 WEATHERPROOF

6 YEAR WARRANTY

# RIBA STRIPLIGHT

Where other lights fear to tread the Riba calls home. Whatever your lighting challenge, the Riba is equipped to match it - and always with style to spare. Be it a confined space or delicate mood lighting, satisfaction is assured.



### Main applications

Under cabinets, entertaining areas, kitchens, home theatres



<b>Power</b>	7.2W	
<b>Lumen output</b>	Warm White	600lm
<b>Efficacy</b>	Warm White	50lm/W
<b>Colour temperature</b>	Warm White	3,000K
<b>CRI</b>	80+	
<b>Lifespan</b>	30,000h	
<b>Package contents</b>	LDR01N700/36: 1m LED strip 7.2W & plug-in 36W transformer LSL013K: 1m LED strip with quick-connector	

**Installation** Starter kit (cat no LDR01N700/36) contains plug-in transformer with 1m LED strip. Additional inter-connectible 1m LED strips available (cat no LSL013K). Connect up to 5m of LED strips on one transformer. LED strips can be cut off every 10cm.

<b>Product codes</b>	LED striplight (1m) and transformer	<b>LDR01N700/36</b>
	LED striplight (1m) and quick-connector	<b>LSL013K</b>

**600 LUMENS**  
**QUICK CONNECT UP TO 5M**  
**3 YEAR WARRANTY**



STRIPLIGHT



# MIKA

EXTERIOR UP/DOWN LIGHT (7W)

The Mika outdoor wall light features a modern design with smooth curved lines perfect for adding a contemporary look to gardens, patios and alfresco areas. This wall light casts both up and down providing ambient illumination to any outdoor space.



↑  
Light flows both  
up and down  
↓

**Main applications**

Exterior walls, pillars,  
front entrances and alfresco areas

<b>Power</b>	7W	
<b>Lumen output</b>	Warm White	350lm
<b>Efficacy</b>	Warm White	50lm/W
<b>Colour temperature</b>	Warm White	3,000K
<b>CRI</b>	80+	
<b>Lifespan</b>	30,000h	
<b>Construction</b>	Anodised aluminium	
<b>Package contents</b>	7W LED up/down light fixture with allen key for mounting, wall plugs and screws	
<b>Product code</b>	Aluminium Finish Warm White Light	<b>LWL063KPS</b>

**BEAM  
ANGLE 120°**

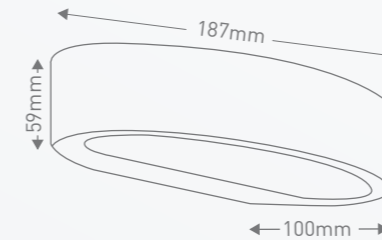

**350  
LUMENS**

**UP DOWN  
LIGHT BEAM**

**IP54  
WEATHERPROOF**

**6 YEAR  
WARRANTY**



# KYRA

EXTERIOR UP/DOWN LIGHT (7.5W)

The multi-talented Kyra represents the ultimate in lighting versatility. Fitted with adjustable panels, Kyra effortlessly oscillates from an uplight to a downlight, or even both. Ideal for highlighting entrances or pillars. Weatherproof rated IP54.



↑  
Light can flow  
up, down or both  
up and down  
↓



**TIP**

Use in conjunction with Legrand 3 wire outdoor sensors to automatically switch on lights when movement is detected

**Main applications**

Exterior walls, pillars, front entrances

<b>Power</b>	7.5W
<b>Lumen output</b>	Warm White 430lm
<b>Efficacy</b>	Warm White 57lm/W
<b>Colour temperature</b>	Warm White 3,000K
<b>CRI</b>	80+
<b>Lifespan</b>	30,000h
<b>Construction</b>	Anodised aluminium
<b>Package contents</b>	7.5W LED up/down light fixture allen key for mounting, wall plugs and screws
<b>Product code</b>	Aluminium Finish Warm White Light <b>LWL023KPS</b>

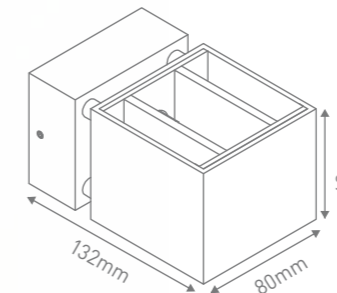

**430**  
LUMENS

UP DOWN  
LIGHT BEAM

**IP54**  
WEATHERPROOF

**6 YEAR**  
WARRANTY



# PINNA

EXTERIOR UP/DOWN LIGHT (10W)

Slimline, discreet, stylish - the Pinna thrives in outdoor spaces. Utilise its dual-direction beam to foster an atmosphere of blissful tranquility. Weatherproof rated IP54 and corrosion resistant.



↑  
Light flows both  
up and down  
↓

<b>Power</b>	10W
<b>Lumen output</b>	Warm White 380lm
<b>Efficacy</b>	Warm White 38lm/W
<b>Colour temperature</b>	Warm White 3,000K
<b>CRI</b>	80+
<b>Lifespan</b>	30,000h
<b>Construction</b>	Corrosion resistant anodised aluminium
<b>Package contents</b>	10W LED up/down light fixture, allen key for mounting, wall plugs and screws
<b>Product code</b>	Aluminium Finish Warm White Light <b>LWL013KPS</b>

~~BEAM~~  
ANGLE 120°

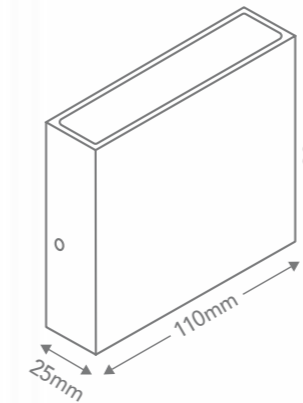

380  
LUMENS

UP DOWN  
LIGHT BEAM

IP54  
WEATHERPROOF

6 YEAR  
WARRANTY

**TIP**

Match Pinna with Legrand Soliroc weatherproof switches and sockets for a harmonious outdoor theme



**Main applications**

Exterior walls, pillars, front entrances and backyard entertainment areas



# OROYA OUTDOOR BUNKER LIGHT (12W)



The Oroya is a great choice as a weatherproof outdoor lighting solution with the versatility of being mounted on a wall or in a ceiling. With a weatherproof IP65 rating, it is the ideal solution as an outdoor oyster light or bunker wall light.

<b>Power</b>	12W	
<b>Lumen output</b>	Cool White	870lm
<b>Efficacy</b>	Cool White	72lm/W
<b>Colour temperature</b>	Cool White	4,000K
<b>CRI</b>	80+	
<b>Construction</b>	UV resistant polycarbonate	
<b>Package contents</b>	12W outdoor light fixture, wall plugs and screws	
<b>Product codes</b>	White Finish Cool White Light	<b>LBL014KWE</b>



Wall or Ceiling Mounting

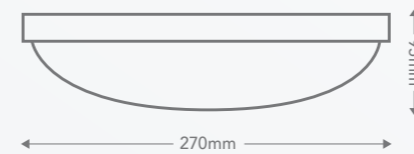

**Main applications**  
Outdoor walls and ceilings





# TWIN FLOODLIGHT WITH SENSOR (29W)

This versatile floodlight features dual lights that can be independently positioned allowing different areas to be illuminated. Ideal for secluded walkways and driveways the PIR sensor automatically activates lights when motion is detected within the detection range.



**TIP**

Passive infrared sensors are sensitive to a person's skin temperature through emitted body radiation, in contrast to background objects at room temperature. No energy is emitted from the sensor, thus the name "Passive Infrared" (PIR)

<b>Power</b>	29W	
<b>Lumen output</b>	Warm White	2,200lm
<b>Efficacy</b>	Warm White	75lm/W
<b>Colour temperature</b>	Warm White	3,000K
<b>CRI</b>	80+	
<b>Lifespan</b>	30,000h	
<b>Head swivel angle</b>	120°	
<b>Sensor detection range/angle</b>	12m / 180°	
<b>Sensor time-delay adjustment</b>	10 (±5) seconds to 4 (±1) minutes	
<b>Sensor type</b>	Passive Infrared (PIR)	
<b>Construction</b>	UV resistant polycarbonate	
<b>Package contents</b>	29W Twin LED floodlight with PIR sensor, wall plugs and screws, 2x14W PAR38 LED lamps	
<b>Product code</b>	Black Finish Warm White Light	<b>LFS013KBL</b>

BEAM ANGLE 120°

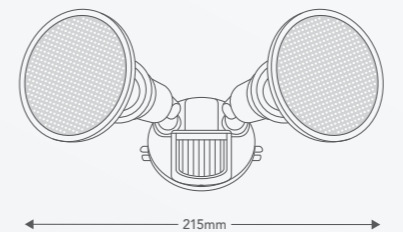

PAR38 replacement LED lamp (LPAR38013K)



2200 LUMENS

ADJUSTABLE TIME-DELAY & LUX LEVEL

IP44 WEATHERPROOF

3 YEAR WARRANTY

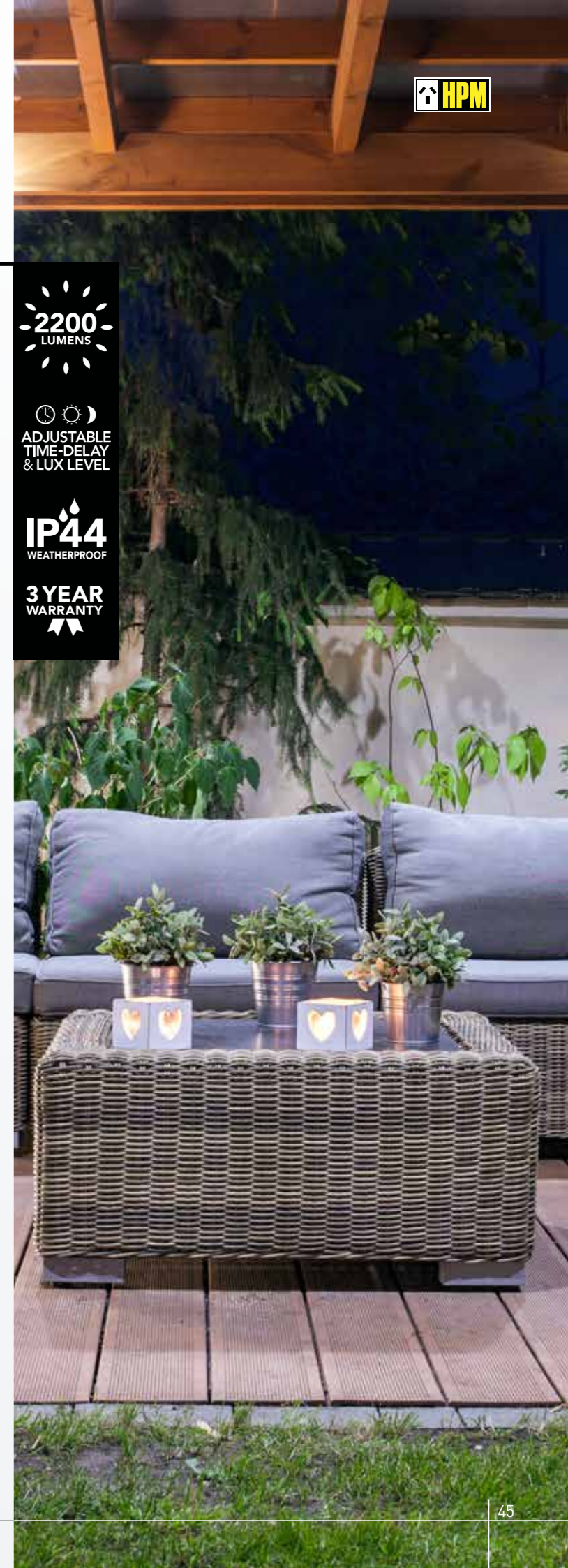



# SIKA FLOODLIGHTS (12W TO 25W)

A great choice for lighting walkways and outdoor areas, this floodlight is a bright energy saver. Its simple design blends seamlessly with any decor style making it a versatile choice. The Sika with motion sensor switches on automatically when movement is detected.



**TIP**

Ideal for driveways, including walkways, front and back porches

<b>Power</b>	12W		25W
<b>Lumen output</b>	Cool White	1,070	2,200lm
<b>Efficacy</b>	Cool White	88lm/W	89lm/W
<b>Colour temperature</b>	Cool White	4,000K	
<b>CRI</b>	80+		
<b>Lifespan</b>	15,000h		
<b>Head swivel angle</b>	130° vertical / 180° horizontal		
<b>Sensor detection range/angle</b>	12m / 180°		
<b>Sensor time-delay adjustment</b>	10 (±5) seconds to 4 (±1) minutes		
<b>Sensor type</b>	Passive Infrared (PIR)		
<b>Sensor manual override</b>	Yes		
<b>Construction</b>	Die-cast aluminium body		
<b>Package contents</b>	12W to 25W LED floodlight, wall plugs and screws		
<b>Product code</b>			
Single spot	12W		<b>LSP0112WBL</b>
Double spot	25W		<b>LSP0125WBL</b>
Single spot	12W with PIR sensor		<b>LSS0112WBL</b>
Double spot	25W with PIR sensor		<b>LSS0125WBL</b>

**BEAM ANGLE 120°**

**LSP0112WBL**

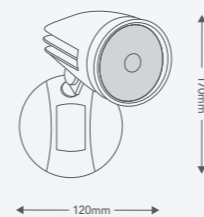

**LSP0125WBL**

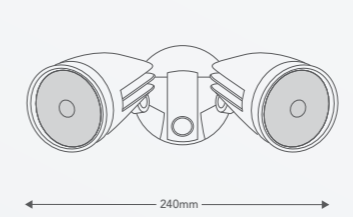

**LSS0112WBL**

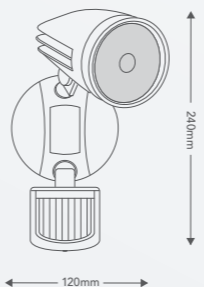

**LSS0125WBL**

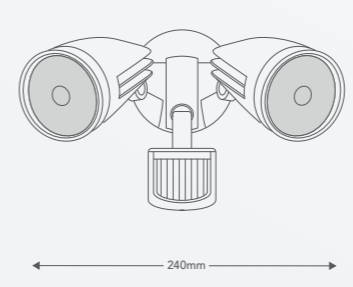

UP TO  
**2200**  
LUMENS

ADJUSTABLE  
TIME-DELAY  
& LUX LEVEL

**IP44**  
WEATHERPROOF

**3 YEAR**  
WARRANTY





# FORTA FLOODLIGHTS (10W TO 40W)



Sporting a slick black, die-cast aluminium body, Forta floodlights look fantastic as well as throw a powerful light. The optional PIR sensor automatically turns on the light when it detects movement, which is both a great energy saving and security feature.



### Main applications

Ideal for driveways, secluded walkways, front and back porches

UP TO  
**3000**  
LUMENS

Sensor options available

**IP44**  
WEATHERPROOF

**3 YEAR**  
WARRANTY

<b>Power</b>	10W   20W   30W   40W	
<b>Lumen output</b>	Cool White 730   1615   2250   3000lm	
<b>Efficacy</b>	Cool White 73   80   75   75lm/W	
<b>Colour temperature</b>	Cool White	4,000K
<b>CRI</b>	80+	
<b>Lifespan</b>	15,000h	
<b>Construction</b>	Die-cast aluminium	
<b>Head swivel angle</b>	180° vertical	
<b>Sensor detection range/angle</b>	12m / 180°	
<b>Sensor time-delay adjustment</b>	10 (±5) seconds to 4 (±1) minutes	
<b>Sensor type</b>	Passive Infrared (PIR)	
<b>Sensor manual override</b>	Yes	
<b>Package contents</b>	LED floodlight with mounting bracket, wall plugs and screws	
<b>Product code</b>	10W	<b>LFL0110WBL</b>
	20W	<b>LFL0120WBL</b>
	30W	<b>LFL0130WBL</b>
	40W	<b>LFL0140WBL</b>
	10W with PIR sensor	<b>LFS0110WBL</b>
	30W with PIR sensor	<b>LFS0130WBL</b>

LFL0110WBL

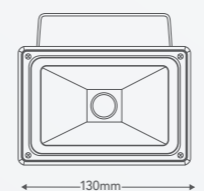

LFL0120WBL

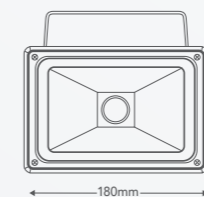

LFL0130WBL

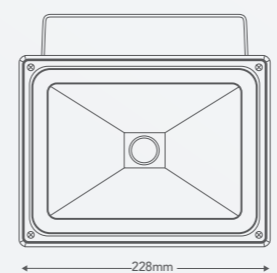

LFL0140WBL

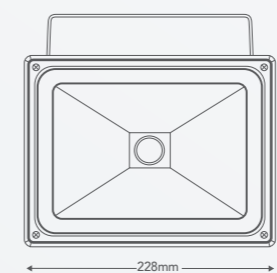

LFS0110WBL

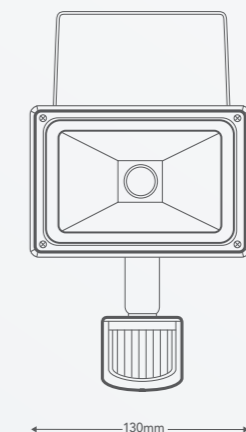

LFS0130WBL

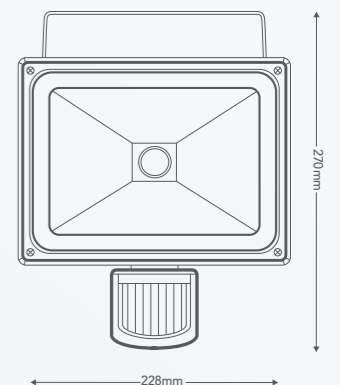

# TORAN

FLOODLIGHT WITH SENSOR (16W)

Ideal for mounting under eaves or for illuminating driveways, the Toran keeps you safe with style. Equipped with a motion sensor for energy saving and an adjustable head which enables 180° flexibility.



#### Main applications

Ideal for driveways, secluded walkways, front and back porches

<b>Power</b>	16W	
<b>Lumen output</b>	Cool White	1,700lm
<b>Efficacy</b>	Cool White	106lm/W
<b>Colour temperature</b>	Cool White	4,000K
<b>CRI</b>	80+	
<b>Lifespan</b>	30,000h	
<b>Head swivel angle</b>	90° vertical / 120° horizontal	
<b>Sensor detection range/angle</b>	12m / 180°	
<b>Sensor time-delay adjustment</b>	10 (±5) seconds to 4 (±1) minutes	
<b>Sensor type</b>	Passive Infrared (PIR)	
<b>Sensor manual override</b>	Yes	
<b>Construction</b>	UV resistant polycarbonate with aluminium heat sink	
<b>Package contents</b>	16W LED floodlight with sensor, wall plugs and screws	
<b>Product code</b>	Black Finish Cool White Light	<b>LFS0316WBL</b>

BEAM  
ANGLE 100°

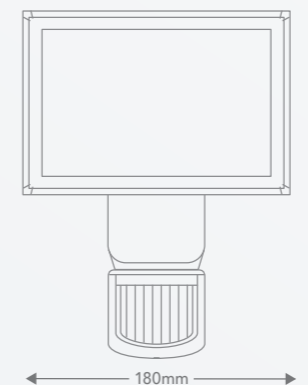

UP TO  
**1700**  
LUMENS

**PIR**  
SENSOR WITH  
MANUAL  
OVERRIDE

**IP44**  
WEATHERPROOF

**3 YEAR**  
WARRANTY





# MAXIS FLOODLIGHT (9W)



The Maxis provides added security to outdoor areas with an integrated PIR motion sensor that lights up automatically when movement is detected.



Horizontal and vertical adjustable head up to 90°

### Main applications

Ideal for driveways, secluded walkways, front and back porches

<b>Power</b>	9W	
<b>Lumen output</b>	Cool White	900lm
<b>Efficacy</b>	Cool White	100m/W
<b>Colour temperature</b>	Cool White	4,000K
<b>CRI</b>	80+	
<b>Lifespan</b>	25,000h	
<b>Head swivel angle</b>	90° vertical and horizontal	
<b>Sensor detection range/angle</b>	8m / 130°	
<b>Sensor time-delay adjustment</b>	10 (±5) seconds to 4 (±1) minutes	
<b>Sensor type</b>	Passive Infrared (PIR)	
<b>Construction</b>	UV resistant polycarbonate	
<b>Package contents</b>	9W LED floodlight with sensor, wall plugs and screws	
<b>Product code</b>	Black Finish Cool White Light	<b>LSS0209WBL</b>

**900 LUMENS**

ADJUSTABLE TIME-DELAY & LUX LEVEL

**IP44 WEATHERPROOF**

**3 YEAR WARRANTY**

BEAM ANGLE 120°

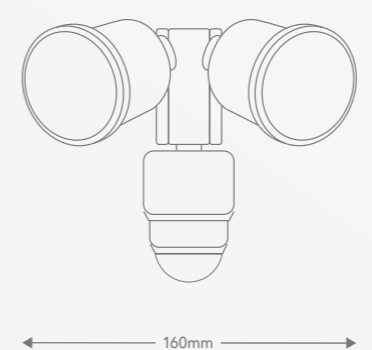



# BAKRA FLOODLIGHT (11W)

Illuminate your outdoor space with the Bakra. The functional design casts a wide spread of light making outdoor spaces brighter and safer.



### Main applications

Ideal for driveways, secluded walkways, front and back porches



<b>Power</b>	11W	
<b>Lumen output</b>	Cool White	1,100lm
<b>Efficacy</b>	Cool White	100lm/W
<b>Colour temperature</b>	Cool White	4,000K
<b>CRI</b>	80+	
<b>Head swivel angle</b>	180° vertical (No sensor) 90° vertical (Sensor)	
<b>Lifespan</b>	15,000h (No sensor) 30,000h (Sensor)	
<b>Construction</b>	UV Resistant ABS Plastic aluminium heat sink	
<b>Sensor detection range/angle</b>	8m / 130°	
<b>Sensor time-delay adjustment</b>	10 (±5) seconds to 4 (±1) minutes	
<b>Sensor type</b>	Passive Infrared (PIR)	
<b>Sensor manual override</b>	No	
<b>Package contents</b>	LED floodlight with mounting brackets, wall plugs and screws	
<b>Product code</b>	Black Finish 11W	<b>LFL0213WBL</b>
	11W with PIR sensor	<b>LFS0214WBL</b>

UP TO  
**1100**  
LUMENS

ADJUSTABLE  
HEAD 180°



**IP44**  
WEATHERPROOF

**3 YEAR**  
WARRANTY

BEAM  
ANGLE 105°

LFL0213WBL

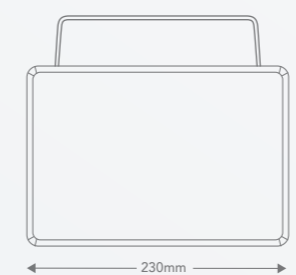

LFS0214WBL

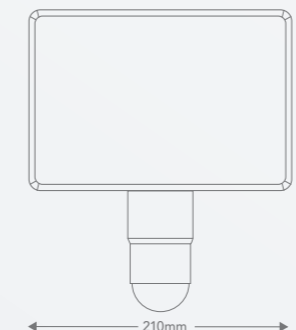

# FORTA WORKLIGHTS (10W TO 40W)



Brighten up a work space on site, at home, in the garage or workshop with a high performing Forta LED worklight. Increase visibility and safety indoors or outdoors with this IP44 weatherproof rated range.

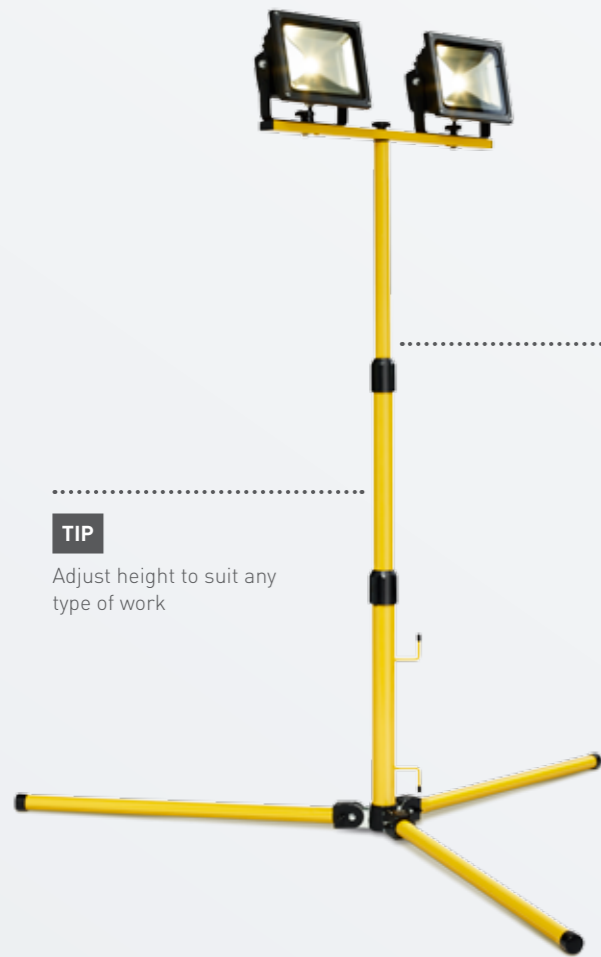

**Main applications**  
Illuminating work spaces

**TIP**  
Adjust height to suit any type of work



UP TO  
**3230**  
LUMENS

**IP44**  
WEATHERPROOF

**EASY**  
PLUG-IN

**3 YEAR**  
WARRANTY

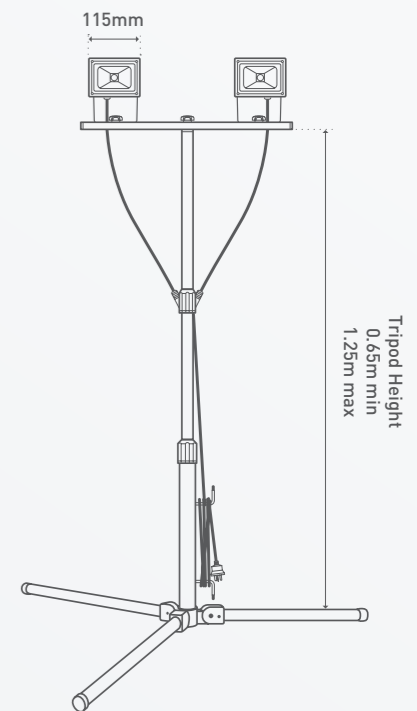
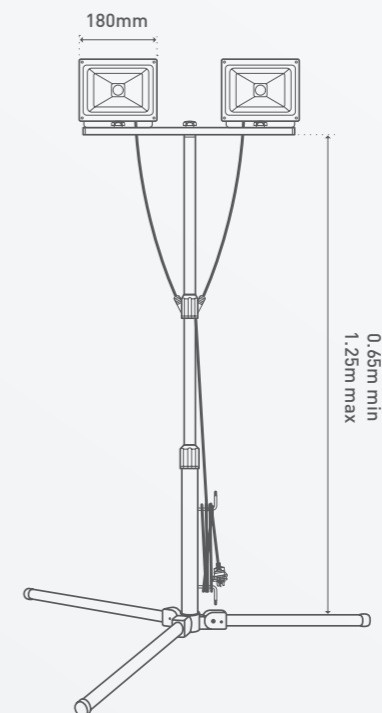
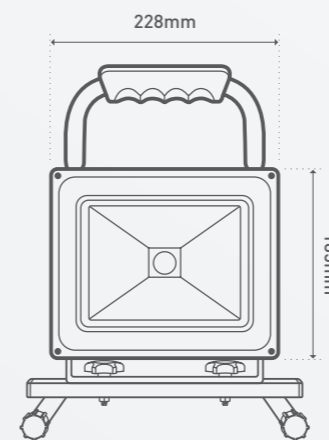
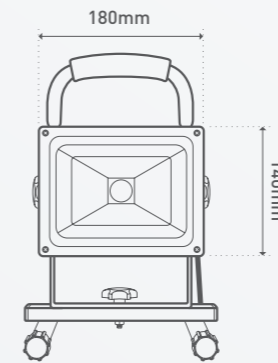
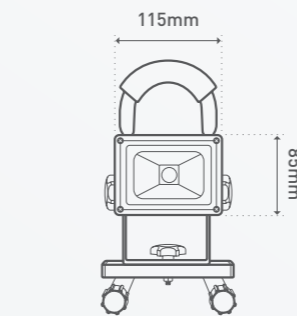

<b>Power</b>		10W   20W   30W   2x10W   2x20W
<b>Lumen output</b>	Cool White	730   1615   2250   2x730   2x1615lm
<b>Efficacy</b>	Cool White	73   80   75   73   80lm/W
<b>Colour temperature</b>	Cool White	4,000K
<b>CRI</b>		80+
<b>Lifespan</b>		15,000h
<b>Construction</b>		Die-cast aluminium
<b>Height Adjustment</b>		Yes tripod
<b>Head swivel angle</b>		180° vertical
<b>Weatherproof rating</b>		IP44
<b>Package contents</b>		LED Worklight with flex and plug
<b>Product code</b>	<b>Portable</b>	
	10W	<b>LWK0110WBL</b>
	20W	<b>LWK0120WBL</b>
	30W	<b>LWK0130WBL</b>
	<b>Tripods</b>	
	2x10W	<b>LWK0220WBL</b>
	2x20W	<b>LWK0240WBL</b>

# LED LIGHTING GLOBES





# A60 LED GLOBES (5W TO 8W)

UP TO  
**1035**  
LUMENS

MAXIMUM EFFICACY  
UP TO 129lm/W

B22 + E27  
OPTIONS

3 YEAR  
WARRANTY

<b>Power</b>	5W	8W	
<b>Lumen output</b>	Warm White	490lm	945lm
	Cool White	520lm	1,035lm
<b>Efficacy</b>	Warm White	98lm/W	118lm/W
	Cool White	104lm/W	129lm/W
<b>Colour temperature</b>	Warm White	3,000K	
	Cool White	4,000K	
<b>CRI</b>	80+		
<b>Lifespan</b>	25,000h		
<b>Base</b>	Bayonet B22   Edison E27		
<b>Package contents</b>	A60 LED Globe 5W or 8W, mounted with Bayonet B22 or Edison E27 base		

<b>Product code</b>	<b>5W Globes</b>	
	Warm White BC	<b>LA60013KBC</b>
	Warm White ES	<b>LA60013KES</b>
	Cool White BC	<b>LA60014KBC</b>
	Cool White ES	<b>LA60014KES</b>
<b>Product code</b>	<b>8W Globes</b>	
	Warm White BC	<b>LA60023KBC</b>
	Warm White ES	<b>LA60023KES</b>
	Cool White BC	<b>LA60024KBC</b>
	Cool White ES	<b>LA60024KES</b>

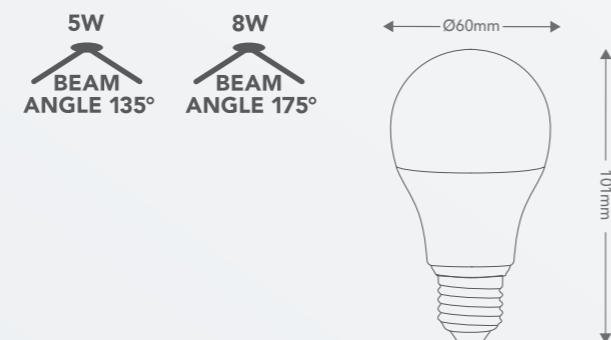

BAYONET B22 (BC)

EDISON E27 (ES)

# A60 FILAMENT LED GLOBES (3.7W)

500  
LUMENS

MAXIMUM EFFICACY  
UP TO 135lm/W

B22 + E27  
OPTIONS

3 YEAR  
WARRANTY

<b>Power</b>	3.7W	
<b>Lumen output</b>	Warm White	500lm
<b>Efficacy</b>	Warm White	135m/W
<b>Colour temperature</b>	Warm White	3,000K
<b>CRI</b>	80+	
<b>Lifespan</b>	10,000h	
<b>Base</b>	Bayonet B22   Edison E27	
<b>Package contents</b>	A60 filament LED Globe 3.7W mounted with Bayonet B22 or Edison E27 base	
<b>Product code</b>	Warm White BC	<b>LA6001FILBC</b>
	Warm White ES	<b>LA6001FILES</b>

BEAM ANGLE 280°

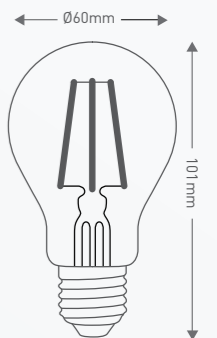

TIP

Ideal for pendants and chandeliers



BAYONET B22 (BC)

EDISON E27 (ES)

# A60 INSECT LED GLOBES (5W)

UP TO  
**460**  
LUMENS



Less attractive to insects

**B22 + E27**  
OPTIONS



**3 YEAR**  
WARRANTY

Power	5W	
Lumen output	460lm	
Efficacy	92lm/W	
Light Colour	Yellow	
Lifespan	25,000h	
Base	Bayonet B22   Edison E27	
Package contents	A60 LED Globe 5W mounted with Bayonet B22 or Edison E27 base	
Product code	BC	<b>LA6001BUGBC</b>
	ES	<b>LA6001BUGES</b>

BEAM  
ANGLE 210°

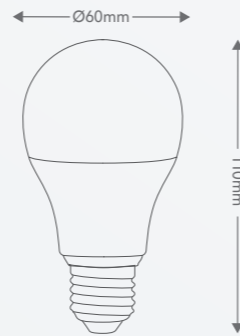

BAYONET B22 (BC)

EDISON E27 (ES)

### Main applications

Specially turned colour filter so that light is less attractive to insects

# CANDLE LED GLOBES (3W TO 5W)

300  
LUMENS



**3 YEAR**  
WARRANTY

Power		3W	5W
Lumen output	Warm White	300lm	560lm
Efficacy	Warm White	100lm/W	112lm/W
Colour temperature	Warm White	3,000K	
CRI	80+		
Base	Edison Screw E14		
Package contents	Candle 3W or 5W mounted with Edison E14 Base		
Product code	3W Warm White SES	<b>LCA013KSES</b>	
	5W Warm White SES	<b>LCA023KSES</b>	

BEAM  
ANGLE 180°

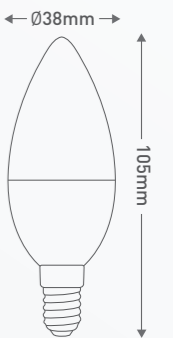

EDISON E14 (SES)

### Main applications

Chandeliers, table lamps and various luminaires

# GU10 LED GLOBES (5W)

UP TO  
**500**  
LUMENS

MAXIMUM EFFICACY  
UP TO 100lm/W

**3 YEAR**  
WARRANTY

<b>Power</b>	5W	
<b>Lumen output</b>	Warm White	460lm
	Cool White	500lm
<b>Efficacy</b>	Warm White	92lm/W
	Cool White	100lm/W
<b>Colour temperature</b>	Warm White	3,000K
	Cool White	4,000K
<b>CRI</b>	80+	
<b>Lifespan</b>	15,000h	
<b>Base</b>	GU10	
<b>Package contents</b>	5W LED Globe with GU10 base	
<b>Product code</b>	<b>5W LED Globes</b>	
	Warm White	<b>LGU10013K</b>
	Cool White	<b>LGU10014K</b>

BEAM  
ANGLE 65°

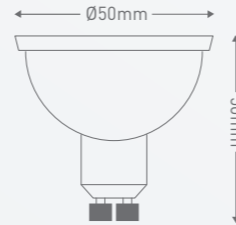

GU10

**Main applications**

Perfect upgrade of existing GU10 halogen fixtures

# PAR38 LED GLOBE (14W)

UP TO  
**1100**  
LUMENS

EDISON  
E27

**3 YEAR**  
WARRANTY

<b>Power</b>	14W	
<b>Lumen output</b>	Warm White	1,100lm
<b>Efficacy</b>	Warm White	78lm/W
<b>Colour temperature</b>	Warm White	3,000K
<b>CRI</b>	80+	
<b>Lifespan</b>	30,000h	
<b>Base</b>	Edison E27	
<b>Package contents</b>	PAR38 Globe 14W mounted with Edison E27 base	
<b>Product code</b>	Warm White ES	<b>LPAR38013K</b>

BEAM  
ANGLE 120°

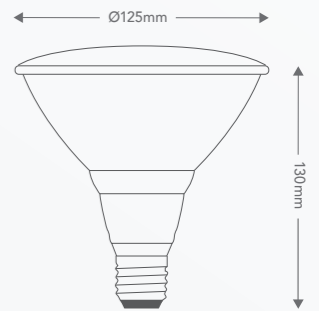

EDISON E27 (ES)



# R63 LED GLOBE (5.7W)

570 LUMENS

EDISON E27

3 YEAR WARRANTY

Power	5.7W	
Lumen output	Warm White	570lm
Efficacy	Warm White	100lm/W
Colour temperature	Warm White	3,000K
CRI	80+	
Lifespan	25,000h	
Base	Edison E27	
Package contents	R63 LED Globe 5.7W mounted with Edison E27 base	
Product code	Warm White ES	LR63013KES

BEAM ANGLE 110°



EDISON E27 (ES)

# R80 LED GLOBES (7W TO 7.5W)

UP TO 700 LUMENS

Dimmable option

MAXIMUM EFFICACY UP TO 100lm/W

3 YEAR WARRANTY

Power	7W	7.5W	
Lumen output	Warm White	580lm	650lm
	Cool White	700lm	690lm
Efficacy	Warm White	82lm/W	86lm/W
	Cool White	100lm/W	92lm/W
Colour temperature	Warm White	3,000K	
	Cool White	4,000K	
CRI	80+		
Dimming	Trailing edge dimmers		
Lifespan	18,000h (7W)		25,000h (7.5W)
Base	Edison E27		
Package contents	7W or 7.5W LED Globe with Edison E27 base		

Product code	<b>7W Globes Non dimmable</b>
	Warm White <b>LR80023K</b> Cool White <b>LR80024K</b>
Product code	<b>7.5W Globes Dimmable</b>
	Warm White <b>LR80023KD</b> Cool White <b>LR80024KD</b>

BEAM ANGLE 110°

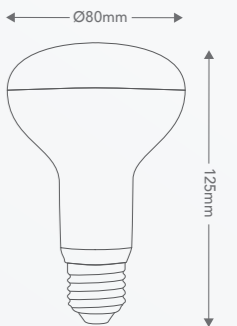

**Main applications**

Bathroom heater centre light  
Reflector type downlights



EDISON E27 (ES)

# ACCESSORIES

## DOWNLIGHT EXTENSION PLATES



CAT NO.	
LEP120WE	Suitable for hole cut-outs up to Ø120mm
LEP150WE	Suitable for hole cut-outs up to Ø150mm

Suitable for: DLI90, AZA+, Dalia, Azalea, and DLS series

## LIGHTING SENSORS

### Passive infrared (PIR) sensor

Sensitive to a person's skin temperature through emitted body radiation, in contrast to background objects at room temperature. HPM range of sensors is suitable for both indoor and outdoor for various locations throughout the house including corridors, wardrobes, secluded walkways and garages.

Whether used for extra safety around the house or convenience indoors these deliver great energy savings all year round.

	Image	Description	Finish	Manual override	IP Rating	Application	Mounting type	Detection range	Detection angle	Time delay
630/3		180° PIR SENSOR	White	Yes	IP44	Indoor/Outdoor	Wall surface mounted	12m	180°	8s to 7min
630/3A		180° PIR SENSOR	White	No	IP44	Indoor/Outdoor	Wall surface mounted	12m	180°	8s to 7min
630/3ABL		180° PIR SENSOR	Black	No	IP44	Indoor/Outdoor	Wall surface mounted	12m	180°	8s to 7min
630/5		360° PIR DETECTOR	White	No	IP41	Indoor	Ceiling surface mounted	10m	360°	6s to 12min
630R02WE		360° RECESSED PIR SENSOR	White	No	IP41	Indoor	Ceiling recessed mounted	8m	360°	10s to 10min
630/9-3W		AQUASCAN 3-WIRE PIR SENSOR	White	No	IP66	Outdoor	Wall surface mounted	12m	110°	15s to 7min
488TRI3W		TRISCAN 3-WIRE PIR SENSOR	White	Yes	IP66	Outdoor	Wall surface mounted	8m	120°	8s to 15min



## DIMMER COMPATIBILITY

LED FIXTURE RANGE	DIMMER TYPE	DIMMERS COMPATIBILITY	MAXIMUM LIGHTS PER DIMMER	DIMMING RANGE
DLI70 Downlights	Trailing edge only	400A3P	16	100%-1%
		400A2P	16	89%-7%
		250T	11	100%-7%
		400T	16	94%-8%
		700T	28	100%-15%
DLI70 Downlights	Trailing edge only	1000T	40	100%-18%
		400A3P	12	100%-1%
		400A2P	12	97%-9%
		250T	8	100%-7%
		400T	12	100%-7%
DLI90 & DLI125 Downlights	Trailing edge only	700T	21	100%-13%
		1000T	30	100%-16%
		400A3P	8	100%-5%
		400A2P	8	100%-10%
Dalia Downlights Azalea Downlights Freesia Downlights Luna Panel Lights Calla Step Lights Zinnia Starlights	Trailing edge & leading edge	250T / 250L	5	100%-10%
		400T / 400L	8	100%-10%
		700T / 700L	14	100%-25%
		1000T / 1000L	20	100%-25%
		400A3P	8	100%-10%
DLS Downlights	Trailing edge only	400A2P	8	100%-10%
		250T	5	100%-10%
		400T	8	100%-10%
		700T	14	100%-25%
		1000T	20	100%-25%
R80 Dimmable Globe	Trailing edge only	400A3P	12	100%-1%
		400A2P	12	92%-10%
		250T	8	100%-7%
		400T	12	100%-8%



Legrand Excel Life



Legrand Arteur



HPM Linea and Excel

### LEGRAND EXCEL LIFE



**EM400A3P (3 wire)**  
**EM400A2P (2 wire)**  
Excel Life 400VA all load 2 & 3 wire electronic push button dimmer mechanism  
**White:**  
EM400A3PWE  
EM400A2PWE  
**Urban Grey:**  
EM400A3PUG  
EM400A2PUG



**EM250T\***  
Excel Life 250VA 2 wire trailing edge rotary dimmer mechanism  
**White:**  
EM250TRWE  
**Urban Grey:**  
EM250TRUG



**EM400T\***  
Excel Life 400VA 2 wire trailing edge rotary dimmer mechanism  
**White:**  
EM400TRWE  
**Urban Grey:**  
EM400TRUG

### LEGRAND ARTEOR



**AR400A3P (3 wire)**  
**AR400A2P (2 wire)**  
Arteur 400VA all load 2 & 3 wire push button dimmer mechanism  
**White:**  
AR400A3PMWE  
AR400A2PMWE  
**Magnesium:**  
AR400A3PMMGN  
AR400A2PMMGN



**AR400T / AR400L\***  
Arteur 400VA 2 wire rotary dimmer mechanism  
**White:**  
AR400TMWE  
AR400LMWE  
**Magnesium:**  
AR400TMMGN  
AR400LMMGN

### HPM LINEA AND EXCEL



**400A2P (2 wire)**  
Excel or Linea and 400VA (2 wire) electronic push button dimmer mechanism  
**White:** 400A2PWE



**250T / 250L\***  
Excel or Linea 250VA 2 wire rotary dimmer mechanism  
**White:** 250LMWE  
250TMWE  
Also available in black & cream



**400T / 400L\***  
Excel or Linea 400VA 2 wire rotary dimmer mechanism  
**White:** 400TMWE  
400LMWE  
Also available in black & cream



**700T / 700L\***  
Excel or Linea 700VA 2 wire rotary dimmer mechanism  
**White:** 700TMWE  
700LMWE



**1000T / 1000L\***  
Excel or Linea 1000VA 2 wire rotary dimmer mechanism  
**White:** 1000TMWE  
1000LMWE







\*T = Trailing Edge, L = Leading Edge

## INDEX OF PROTECTION









### 1. Protection against solid bodies and liquids: IP index of protection

Degrees of protection for enclosures of electrical equipment according to standards: IEC 60529, BS EN 60529 and NF EN 60529

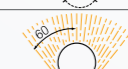
**1<sup>st</sup> digit:**  
**protection against solid bodies**  
(See AS 1939, Clause 5)



IP	Tests	IP
0	No protection	
1	 Protected against solid bodies larger than 50 mm (e.g. accidental contact with the hand)	<b>A</b>
2	 Protected against solid bodies larger than 12.5 mm (e.g. finger)	<b>B</b>
3	 Protected against solid bodies larger than 2.5 mm (e.g. tools, wires)	<b>C</b>
4	 Protected against solid bodies larger than 1 mm (e.g. fine tools and small wires)	
5	 Protected against dust (no harmful deposit)	<b>D</b>
6	 Completely protected against dust	



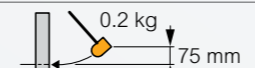
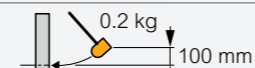

**2<sup>nd</sup> digit:**  
**protection of equipment against ingress of harmful liquids**  
(See AS 1939, Clause 6)

IP	Tests	IP
0	No protection	
1	 Protected against vertically-falling drops of water (condensation)	
2	 Protected against drops of water falling at up to 15° from the vertical	
3	 Protected against drops of rain water at up to 60° from the vertical	
4	 Protected against projections of water from all directions	
5	 Protected against jets of water (from all directions)	
6	 Protected against jets of water of similar force to heavy seas	
7	 Protected against the effects of immersion	
8	 Protected against prolonged effects of immersion	

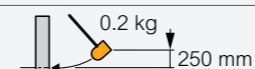
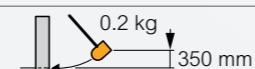
### 2. Protection IK, against mechanical impact.

According to standards: IEC 62262, BS EN 62262 and NF EN 62262

IK	Tests	Impact energy (in Joules)
IK 00		0
IK 01		0.15
IK 02		0.2
IK 03		0.35
IK 04		0.5
IK 05		0.7

IK	Tests	Impact energy (in Joules)
IK 06		1
IK 07		2
IK 08		5
IK 09		10
IK 10		20

• This table can be used to ascertain the resistance of a product to an impact given in Joules from the IK code (graduated from 00 to 10)





A brand of **legrand**



Member of:



**HPM Legrand Australia**  
Building 4 Nexus Industry Park  
43-47 Lyn Pde Prestons NSW 2170  
1300 369 777  
[www.hpm.com.au](http://www.hpm.com.au)

**HPM Legrand New Zealand**  
106-124 Target Road Glenfield  
Auckland 0627 New Zealand  
0800 476 009  
[www.hpm.co.nz](http://www.hpm.co.nz)

HPML0707

10/2016